

Bestway[®]

53368E/53370E/53378E

53382E/53386E

www.bestwayusa.com

OWNER'S MANUAL

IMPORTANT SAFETY INSTRUCTIONS
READ ALL INSTRUCTIONS BEFORE ASSEMBLING THIS INFLATABLE
DEVICE AND KEEP INSTRUCTIONS FOR FUTURE USE.
FAILURE TO FOLLOW THESE INSTRUCTIONS COULD RESULT IN
SERIOUS INJURY OR DEATH.

⚠ WARNING

⚠ WARNING

Electrocution Risk



Keep all electrical lines, radios, speakers, and other electrical devices away from inflatable device. Do not place inflatable device near or under overhead electrical lines.

⚠ WARNING

Prevent Drowning



Children under 5, especially toddlers are at highest risk of drowning. Closely watch children who are **in or near** this inflatable device. Empty inflatable device or prevent access when not in use.

Prevent Young Children from Drowning:

- Install fencing or other approved barrier around all sides of the inflatable device.
- State or local laws or codes may require fencing or other approved barriers. Check state or local laws and codes before setting up the inflatable device.
- Drowning occurs silently and quickly. Assign an adult to supervise the inflatable device.
- Keep children in your direct sight when they are in or near the inflatable device and when you are filling and emptying the inflatable device.
- When searching for a missing child, check the pool first, even if you think your child is in the house.

Be Prepared to Respond to an Emergency:

- Keep a working phone and list of emergency numbers near the inflatable device.
- Become certified in cardiopulmonary resuscitation (CPR) so you can respond to an emergency.

Warning:

- Failure to follow the installation and operating instructions present a risk of serious injury or death.
- Place the inflatable device on level ground, not less than 10ft (3m) in any direction from any structure or obstruction such as a fence, garage, house, overhanging branches, laundry lines, or electrical wires.
- Do not install inflatable device over concrete, asphalt, packed earth, carpet or any other hard surface. A fall onto a hard surface can result in serious injury to the user.
- To be used on soft ground only, the impact absorbing material (eg. Rubber mulch, engineered wood fiber (EWF) etc) shall be at least 6.6ft (2m) from opening in all directions away from the inflatable device.
- Use of this product may cause friction burns to exposed skin. Ensure that clothing fully covers arms and legs, as well as the torso.

Item	Age	Maximum number	Maximum weight capacity			Critical fall height	Maximum fall height
			Platform	Slide	Whole Product		
53368E	5+ years	9	108kg (240lbs)	108kg (240lbs)	490kg (1080lbs)	66.5in. (169cm)	56in. (143cm)
53370E	5-10 years	8	54kg (120lbs)	54kg (120lbs)	436kg (960lbs)	66in. (167cm)	56in. (143cm)
53378E	5-10 years	9	108kg (240lbs)	108kg (240lbs)	490kg (1080lbs)	68in. (172cm)	57in. (145cm)
53382E	3-8 years	5	54kg (120lbs)	54kg (120lbs)	227kg (500lbs)	56in. (143cm)	14in. (35cm)
53386E	5+ years	6	54kg (120lbs)	54kg (120lbs)	327kg (720lbs)	75in. (192cm)	57in. (145cm)

Blower Rating: AC110-120V, 60Hz, 3.5A (53382E)
 AC110-120V, 60Hz, 4.1A (53370E)
 AC110-120V, 60Hz, 5.7A (53368E;53378E;53386E)

⚠ AIR-BLOWER SAFETY INFORMATION

- READ AND SAVE THESE INSTRUCTIONS
- USE ONLY ON GFCI PROTECTED RECEPTACLES

WARNING:

- To reduce the risk of fire or electric shock, do not use this air blower with any solid-state speed control device.
- Prevent sharp and hard objects from dropping into and prevent liquid from flowing into the air blower.
- Do not wash the air blower with liquid, you must first unplug it from power source and then wipe it with wet cloth when you clear it.

• Do not draw and pull motor leads, and do not bump the air blower, you'd better use the air blower between negative five and fifty centigrade. If you let the air blower be baked in the high temperature, motor leads enamelled cables and heating bodies will aging and shorten it's life.

CAUTION - ELECTRICALLY OPERATED PRODUCT:

NOT RECOMMENDED FOR CHILDREN UNDER 14 YEARS OF AGE. AS WITH ALL ELECTRIC PRODUCTS, PRECAUTIONS SHOULD BE OBSERVED DURING HANDLING AND USE TO PREVENT ELECTRIC SHOCK.

KEEP CHILDREN AWAY: Do not allow children to play with or around the unit, in any way, which could result in injury.

PROTECT POWER CORD FROM DAMAGE: Never operate a unit with a damaged power cord, as this may lead to electrical or fire hazards. If the power supply cord is damaged, it must be replaced by a cord of the same type and amperage rating.

This device complies with part 15 of the FCC Rules. Operation is subject to the following two conditions:

(1) This device may not cause harmful interference, and (2) this device must accept any interference received, including interference that may cause undesired operation.

• **Warning:** Any changes or modifications to this unit not expressly approved by the party responsible for compliance could void the user's authority to operate the equipment.

• **NOTE:** This equipment has been tested and found to comply with the limits for a Class B digital device, pursuant to part 15 of the FCC Rules. These limits are designed to provide reasonable protection against harmful interference in a residential installation. This equipment generates, uses and can radiate radio frequency energy and, if not installed and used in accordance with the instructions, may cause harmful interference to radio communications. However, there is no guarantee that interference will not occur in a particular installation. If this equipment does cause harmful interference to radio or television reception, which can be determined by turning the equipment off and on, the user is encouraged to try to correct the interference by one or more of the following measures:

—Reorient or relocate the receiving antenna.

—Increase the separation between the equipment and receiver.

—Connect the equipment into an outlet on a circuit different from that to which the receiver is connected.

—Consult the dealer or an experienced radio/ TV technician for help.

OPERATION

Place the air blower on a steady net surface where children can be kept away. This air blower is for use on a nominal 120-volt circuit and has a grounding plug similar to the plug illustrated in sketch (A). Only connect the product to an outlet having the same configuration as the plug. Do not use an adapter with this product.

Keep Unit Grounded: Air blower should be grounded. In the event of an electrical short circuit, grounding reduces the risk of electric shock by providing an escape wire for the electric current.

This product is equipped with a cord having a grounding wire with an appropriate grounding plug. The plug must be plugged into an outlet that is properly installed and grounded in accordance with all local codes and ordinances.

Warning: Improper installation of the grounding plug is able to result in a risk of electric shock. When repair or replacement of the cord or plug is required, do not connect the grounding wire to either flat blade terminal.

The wire with insulation having an outer surface that is green with or without yellow stripes is the grounding wire.

CAUTION: Check with a qualified electrician or serviceman when the grounding instructions are not completely understood, or when in doubt as to whether the air blower is properly grounded. Do not modify the plug provided. If it will not fit the outlet, have the proper outlet installed by a qualified electrician. The appliance must be positioned so that the plug is accessible. If the supply cord is damaged, it must be replaced by the manufacture or its service agent or a similarly qualified person in order to avoid a hazard.

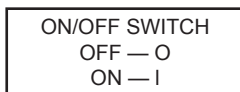
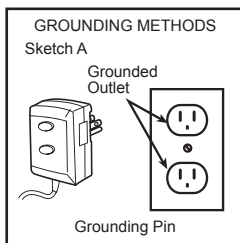

GFCI Test

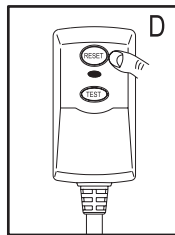
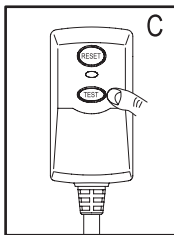
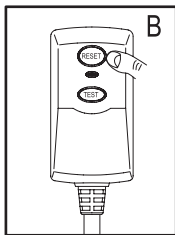
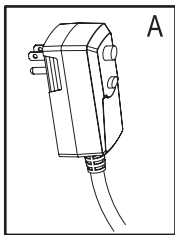

A. To test the GFCI plug, insert it into a grounding type receptacle.

B. Press the "RESET" button; the indicator turns red.

NOTE: If the indicator light is not on, the test has failed.

C. Press the "TEST" button. The indicator turns off.

NOTE: If the indicator light is not off, the test has failed.

D. Press the "RESET" button, the indicator light turns red, and the blower is ready for use.

WARNING: Risk of electric shock. The GFCI must be tested before each use.

WARNING: Do not use the blower if the above test fails. Please contact your local Bestway Customer Service.

Setup Instruction

⚠ WARNING

Follow Anchoring Instructions

User must read and follow anchoring instructions to ensure the proper: number of anchors used, soil conditions, and stake installation.



Wind Speed Judgement

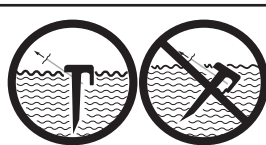

Stake Angle

Placement:

Use on a flat, grassy area only. Do not use on pavement or hard surfaces. Usage area should be free of rocks, bumps, holes, sticks, etc. The water park setup location should have a minimum distance of 10ft (305cm) from any free-standing structures or obstructions. This include: houses, garages, fences, trees, playground equipment, large rocks, etc.

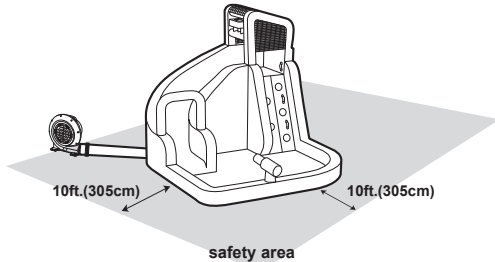

Assembly

Place on level ground and firm grass or soil to allow proper use of stakes.

Do not set up the inflatable device on a slope or incline.

Stakes are to be driven straight down until the top of the stake is below ground level. Do not drive stakes at an angle.

For best holding strength, drive stakes into hard, dry soil. In loose or wet soil, or both, stake holding strength will be reduced.

The number of anchor points is the same as that of anchor stakes in the part list.

Do not use the product if wind speed exceeds 20 mph.

Do not set up in windy or rainy conditions: sudden gust of wind may lift the product off the ground.

Only the blower provided or other manufacturer specified replacement blower should be used for inflation.

Use only with Ground Fault Circuit Interrupter(GFCI) receptacle.

Do not use extension cords with this product and keep the blower and power cord away from water.

Product shall be fully inflated and anchored before use.

Attention: Each anchor bag should be filled to 40lbs.(18kg) of water. Each anchor bag must be attached while using the park (If your product is equipped with anchor bag).

After inflation, the blower should run continuously while children are playing.

Draining & Deflation

IMPORTANT: Drain the water park of all water to prevent mold and mildew. Product should be completely dry before storage. Do not fold and store water park if any moisture remains.

IMPORTANT: All children must exit the water park before deflation or draining.

1. Turn off the garden hose and disconnect it from the tube.
2. Turn off the blower motor and unplug it from the outlet. Move the blower to dry ground if it appears that it will get wet from draining water.
3. Open the water valve and drain the water.
4. Remove stakes and drag water park away from the drained water to a dry area.
5. Re-stake the water park and blower, tie the inflation tube to the blower, then reconnect and power up the blower.
6. Leave the water park inflated until all remaining water has evaporated and the water park is dry.
7. Once water park is completely dry, turn off the blower and unplug it from the outlet.
8. Remove and drain the hose assembly from the Water park. Untie the drawstring from the short outlet tube and allow the water park to fully deflate. Remove the hose assembly and wrap it up with no kinks.

WARNING

- Constant, competent adult supervision of children and other young users is required at all times in front of the device where all parts of play areas can be seen.
- Keep the area around the product clean, and clear of objects, to prevent slips and falls.
- Always check all anchors before and during use.
- To prevent electric shock, do not clean the blower with water.
- Children should not wear loose or baggy clothing, scarves, hoods or clothing with drawstrings or long cords while playing in this product.
- Children must remove helmets, loose clothing, scarves, headgear, shoes and glasses, as well as any sharp or hard objects from their pockets, as they may puncture the bounding surface.
- Separation of larger children from smaller children. Do not allow children to play together who are unevenly matched in weight and height.
- Do not allow users to climb or hang on containment walls.
- Do not allow users to do somersaults or rough play.
- Do not allow food, drink or gum inside unit.
- Children must not slide down head first on their stomach.
- Keep pets away from product.
- Do not attach items to the inflatable device that are not specifically designed for use with the inflatable device, such as, but not limited to, jump ropes, clothesline, pet leashes, cables and chain as they have the potential to cause a strangulation hazard.

MAINTENANCE OF WATER PARK

1. To keep the product clean: wipe the inflatable device using a dry cloth or a cloth dampened with a neutral, non-flammable, non-toxic cleaning and sanitizing solution or pure water.
2. If applicable, remove water and debris from pocket steps after each play cycle.
3. As an outdoor product, the inflatable device is subject to wear and deterioration. Inspect for signs of fabric failure; weak or torn surface must be repaired promptly.

MAINTENANCE OF AIR BLOWER

The source of electrical supply must be disconnected prior to any servicing or cleaning.

1. Use a dry cloth to gently clean all surfaces.
2. Store in a cool, dry place and out of children's reach.

Storage

IMPORTANT:

1. Never store the water park when wet. Allow to dry before folding for storage. Follow all previous instructions each use.
2. Store park in a secure place away from children to prevent suffocation hazards. Never leave either the park or the blower outside when not in use.
3. Please place it the dry and ventilated position where is not sour, not alkali and not corrosive gases. After having used it in outdoors, you should place it in a dry and ventilated room in time. Do not let water into the air-blower.

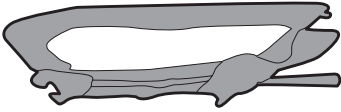
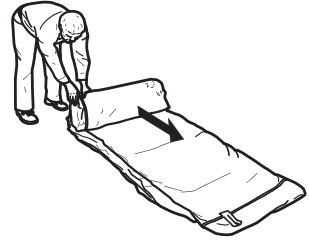
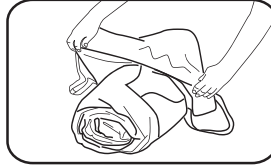
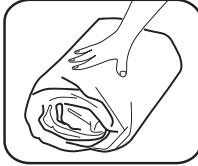
1**2****3**

Troubleshooting

PROBLEM	CAUSE
Motor won't run	<ol style="list-style-type: none"> 1. Switch not turned on. 2. The circuit is opened or it is poor contact. 3. Electric capacity is damaged. 4. Choked up by hard objects.
Motor runs but wheel makes a scraping noise	<ol style="list-style-type: none"> 1. Screws on the vaned wheel are loose. 2. Foreign objects in air-blower.
Motor is unable to run normally	<ol style="list-style-type: none"> 1. The voltage is unstable. 2. Motor is affected with damp. 3. Electric capacity is failure. 4. The impeller is loose.

53368E



001 x 1

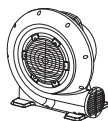

002 x 1



003 x 2



004 x 1



005 x 13

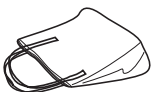

006 x 1



007 x 1



008 x 1

53368E

1

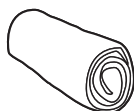

2



3

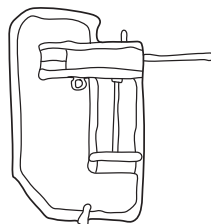

4

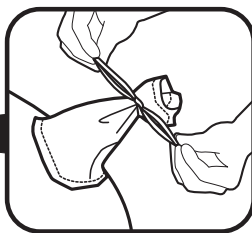
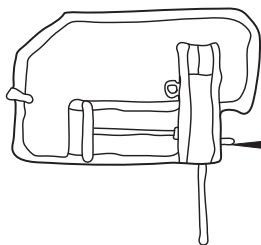

5

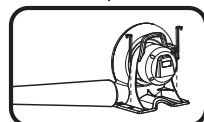
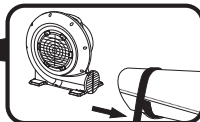
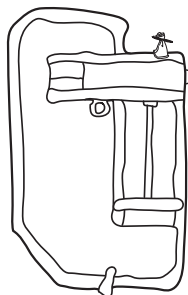

6

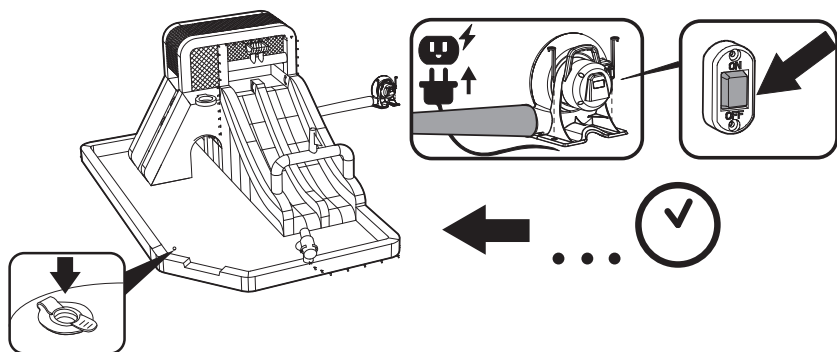

7

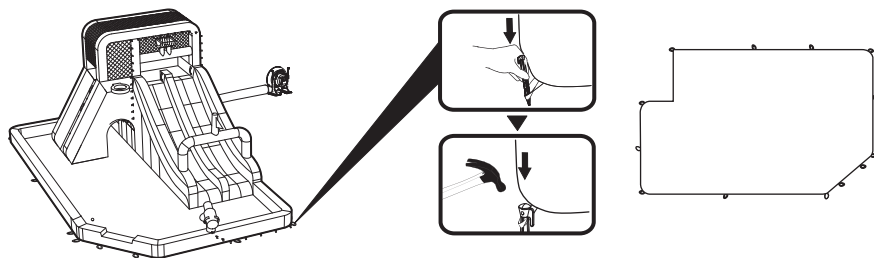

8

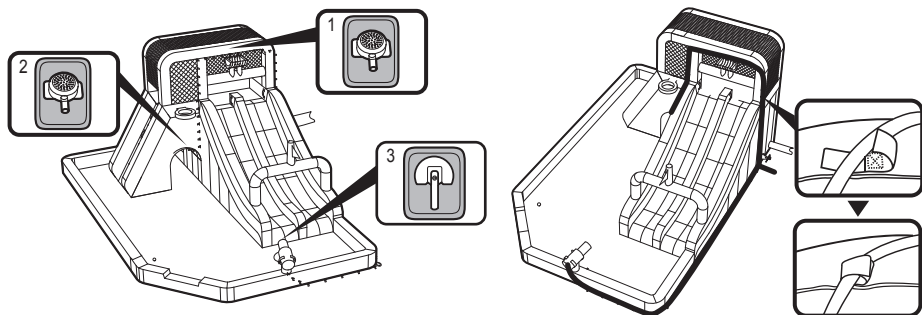

9

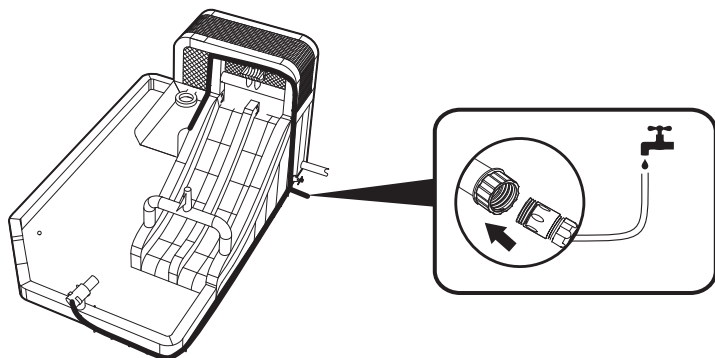

53370E



001 x 1



002 x 1



003 x 2



004 x 1



005 x 11



006 x 1



007 x 1

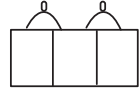

008 x 1

53370E

1



2

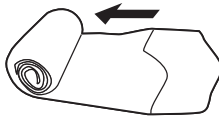

3

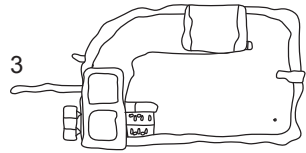

4

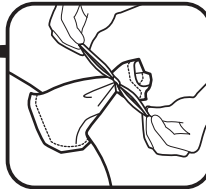
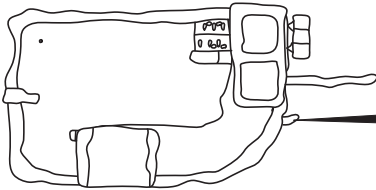

5

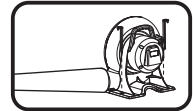
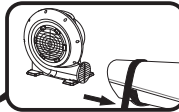
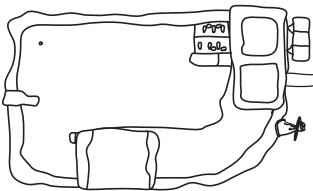

6

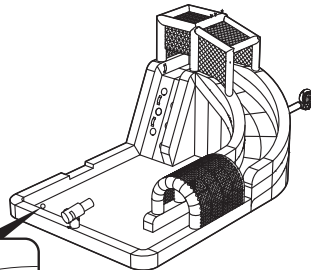
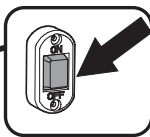
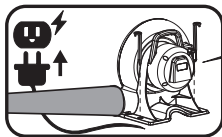

7

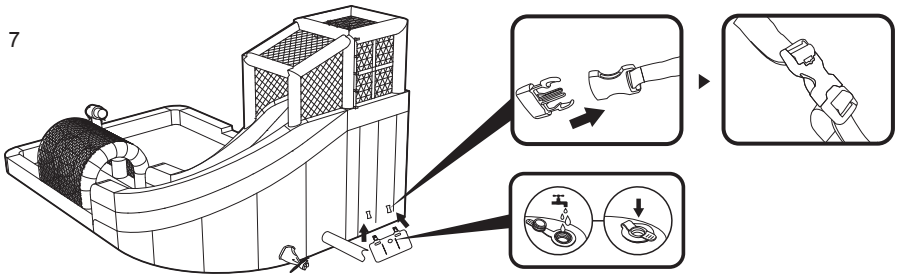

8

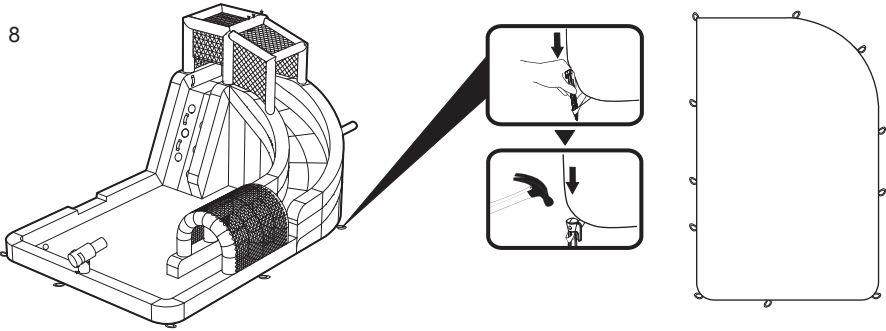

9

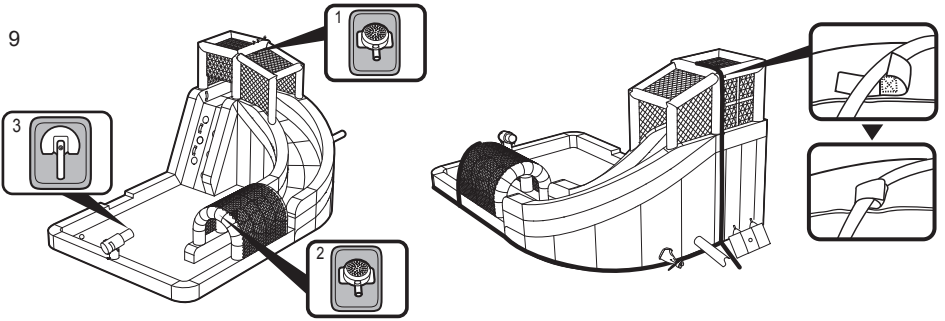

10

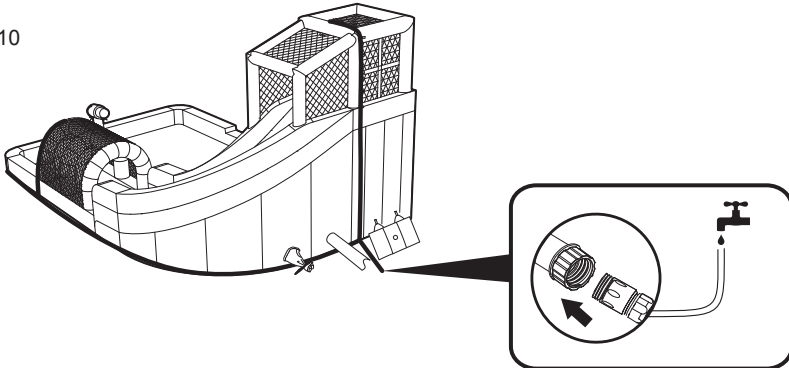

53378E



001 x 1

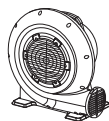

002 x 1



003 x 2



004 x 1



005 x 10



006 x 1



007 x 1



008 x 1

53378E

1

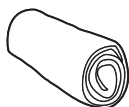

2



3

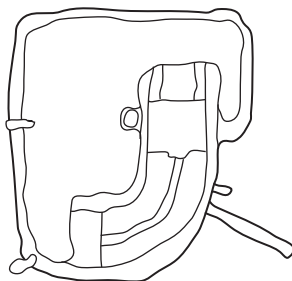

4

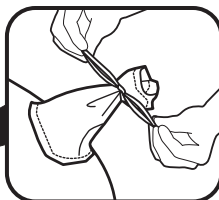
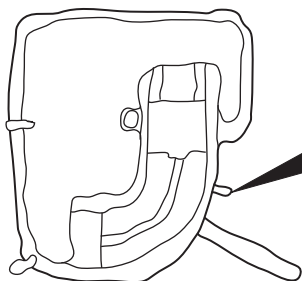

5

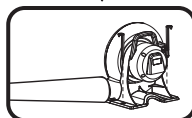
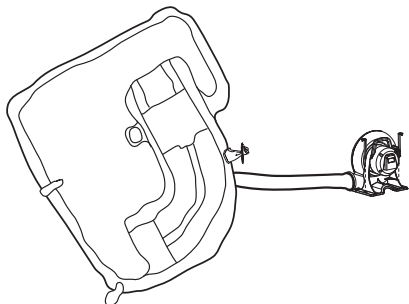

6

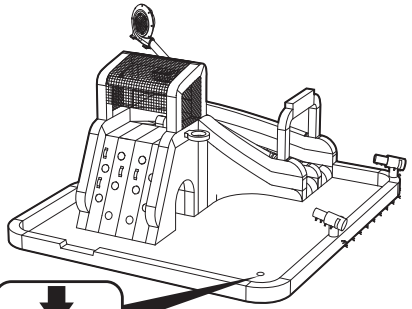
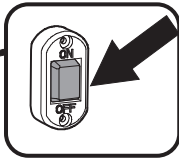
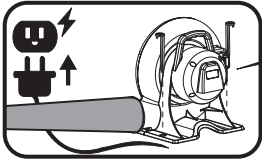

7

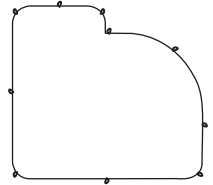
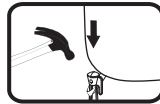
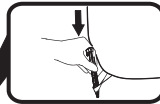
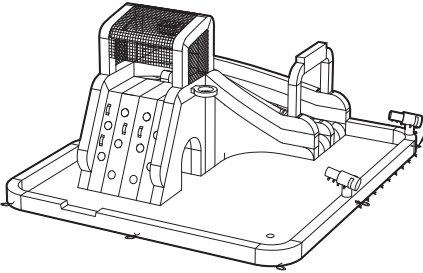

8

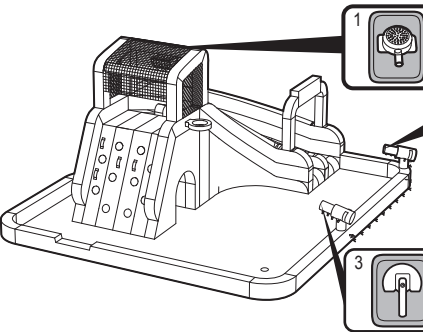

9

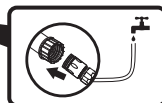
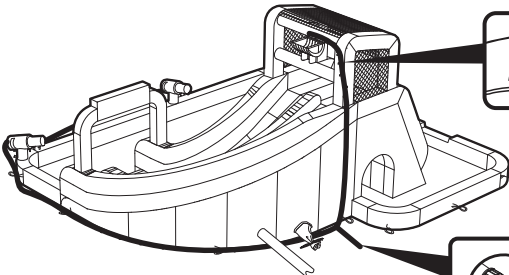

53382E



001 x 1



002 x 1



003 x 2



004 x 1



005 x 8



006 x 1



007 x 1

53382E

1

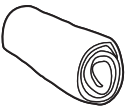

2

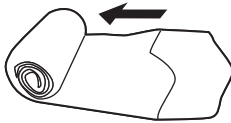

3

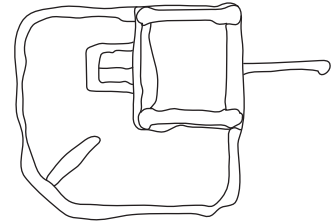

4

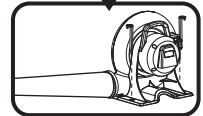
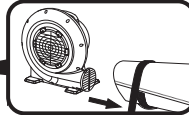
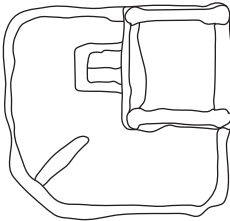

5

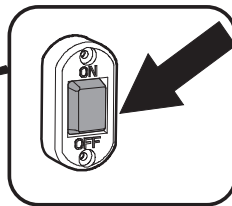
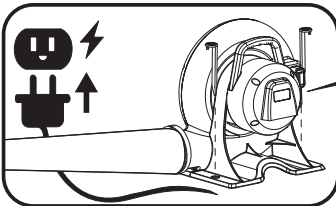

6

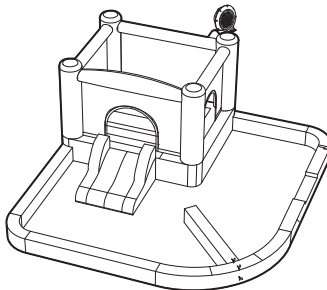

7

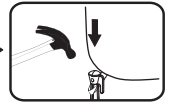
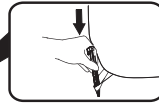
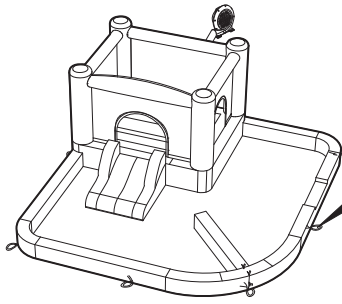
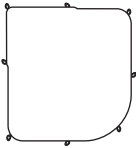

8

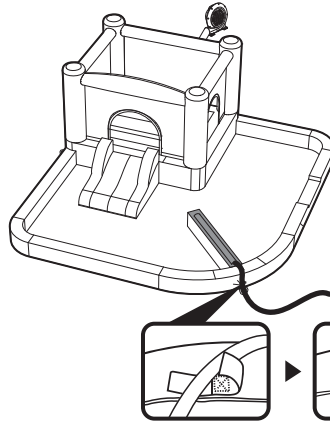
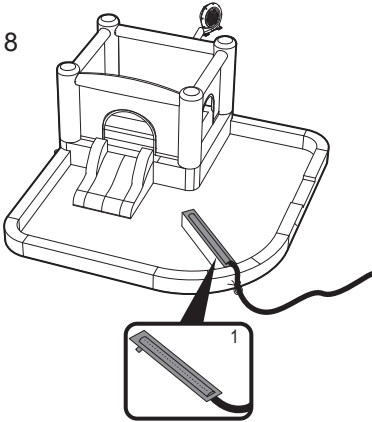

53386E



001 x 1



002 x 1



003 x 2



004 x 1



005 x 13



006 x 1

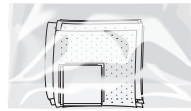

007 x 1

53386E

1

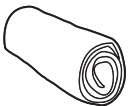

2



3

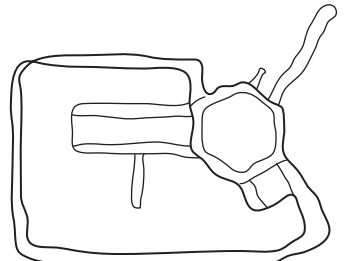

4

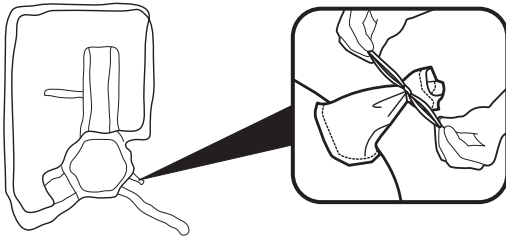

5

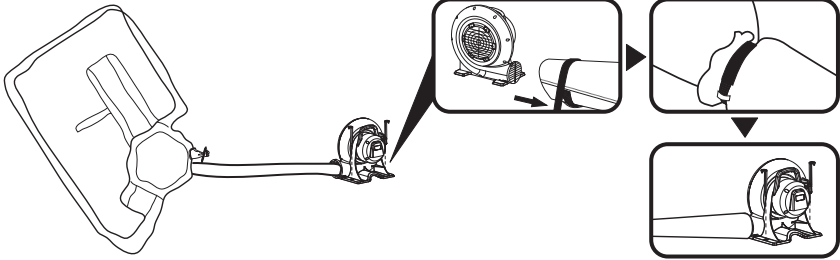

6

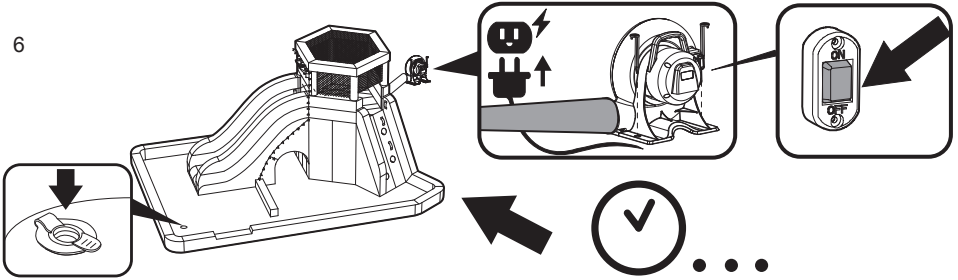

7

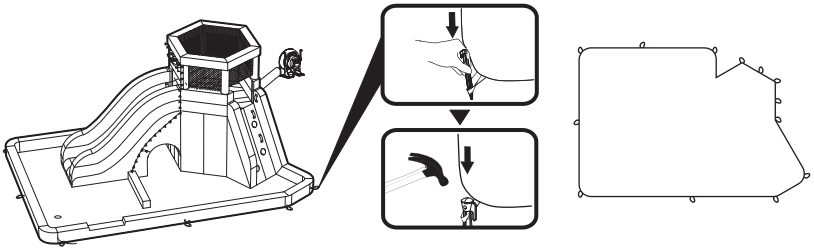

8

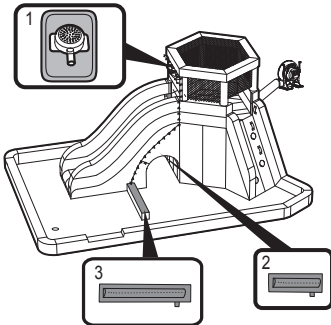

9

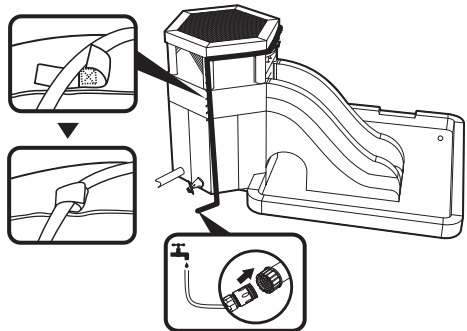

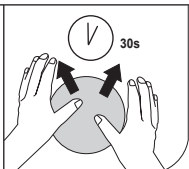
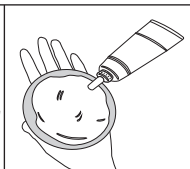
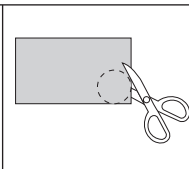
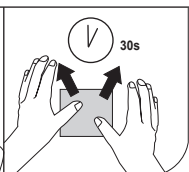
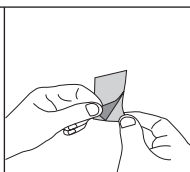
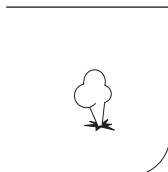
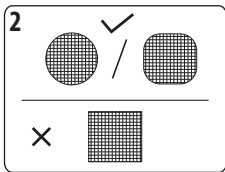
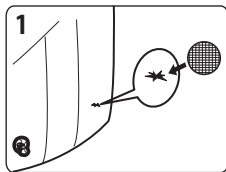

©2022 Bestway Inflatables & Material Corp.

All rights reserved

Trademarks used in some countries under license from Bestway Inflatables & Material Corp., Shanghai, China

Exported by Bestway (Hong Kong) International Ltd./Bestway Enterprise Company Limited

Suite 713, 7/Floor, East Wing, Tsim Sha Tsui Centre, 66 Mody Road, Kowloon, Hong Kong

Distributed in North America by Bestway (USA) Inc., 3435 S. McQueen Road, Chandler, AZ 85286, United States of America

Tel: +86 21 69135588

www.bestwayusa.com

Bestway