



OWNER'S MANUAL

Built-in AlwaysAire™ P3074 AC Electric Pump

©2022 Bestway Inflatables & Material Corp.

All rights reserved

Trademarks used in some countries under license from Bestway Inflatables & Material Corp., Shanghai, China

Exported by Bestway (Hong Kong) International Ltd./Bestway Enterprise Company Limited

Suite 713, 7/Floor, East Wing, Tsim Sha Tsui Centre, 66 Mody Road, Kowloon, Hong Kong

Distributed in North America by Bestway (USA) Inc., 3435 S. McQueen Road, Chandler, AZ 85286, United States of America

Tel: +86 21 69135588

www.bestwayusa.com

IMPORTANT SAFETY INSTRUCTIONS

READ AND FOLLOW ALL INSTRUCTIONS.

Carefully read, understand, and follow all information in this user manual before installing and using the air mattress.

These warnings, instructions, and safety guidelines address some common risks, but they cannot cover all risks and dangers in all cases. Always use caution, common sense, and good judgement when enjoying the air mattress. Retain this information for future use. In addition, the following information can be supplied depending on the air mattress type.

Safekeeping the instruction. If instruction is missing, search it on the website www.bestwayusa.com/support.

• FOR INDOOR USE ONLY. HOUSEHOLD USE ONLY.

- To avoid the risk of electric shock, do not expose to water or rain.
- Infants have suffocated on inflatable mattresses. Never place infant aged birth to 15 months to sleep on this inflatable air mattress. Infants can suffocate on an underinflated or deflated mattress, on bedding, by co-sleeping with another person, and by entrapment between the mattress and bed frame or between the mattress and a vertical surface.
- Children can be entrapped between the inflatable mattress and an adjacent vertical surface. Provide at least a shoulder width space between the inflatable mattress and adjacent vertical surfaces such as walls, dressers, or other objects.
- Always keep the inflatable mattress fully inflated when in use.
- This appliance has a polarized plug (one blade is wider than the other). To reduce the risk of electric shock, this plug is intended to fit in a polarized outlet only one way. If the plug does not fit fully in the outlet, reverse the plug. If it still does not fit, contact a qualified electrician. Do not attempt to defeat this safety feature.
- To reduce the risk of electric shock, do not expose to rain. Store indoors.
- Motor run time should not exceed 5 minutes. Operator should allow motor to cool for 5 minutes between uses.
- Double Insulation- When servicing, use only identical replacement parts.
- This device complies with part 15 of the FCC Rules. Operation is subject to the following two conditions: (1) This device may not cause harmful interference, and (2) this device must accept any interference received, including interference that may cause undesired operation.
- Any changes or modifications to this unit not expressly approved by the party responsible for compliance could void the user's authority to operate the equipment.
- This equipment has been tested and found to comply with the limits for a Class B digital device, pursuant to part 15 of the FCC Rules. These limits are designed to provide reasonable protection against harmful interference in a residential installation. This equipment generates, uses and can radiate radio frequency energy and if not installed and used in accordance with the instructions, may cause harmful interference to radio communications. However, there is no guarantee that interference will not occur in a particular installation. If this equipment does cause harmful interference to radio or television reception, which can be determined by turning the equipment off and on, the user is encouraged to try to correct the interference by one or more of the following measures:
 - Reorient or relocate the receiving antenna.
 - Increase the separation between the equipment and receiver.
 - Connect the equipment into an outlet on a circuit different from that to which the receiver is connected.
 - Consult the dealer or an experienced radio/TV technician for help.

USING THE AIRBED

- — **Green light:** When the green light is on, the air mattress has reached optimal air pressure. Turn the knob to the off position. When the Green light is flashing, the airbed is ready to be inflated.
- — **Blue light:** When the blue light is on, the secondary pump has turned on. When the green light and blue lights are flashing, it is an alarm. It means the air mattress cannot reach the designated air pressure level. Check the air mattress to ensure the valve is tightened and there is no air leak.
- ⏻ — **USB port:** Can be used when the pump plugs into the wall socket.
Specification: DC 5V 1A
- 💡 — **Night light**

- Don't unplug the pump. To fully enjoy the benefits of the dual pump's features, leave it plugged in.
- Drawings for illustration purpose only. May not reflect actual product. Not to scale.

INFLATION

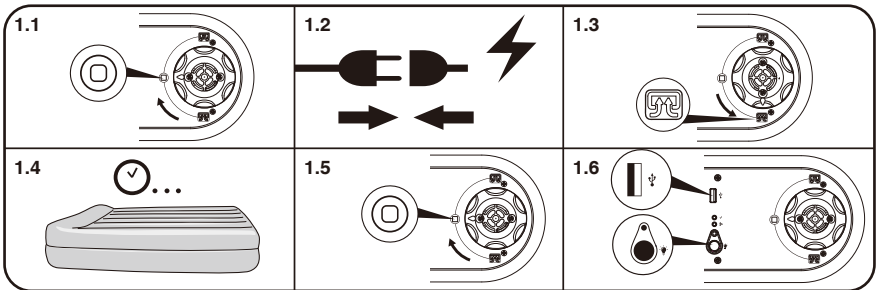

- When the bed is inflated for the first time after a long time in the package, it will appear wrinkled. The wrinkles will disappear after being inflated for 24 hours.

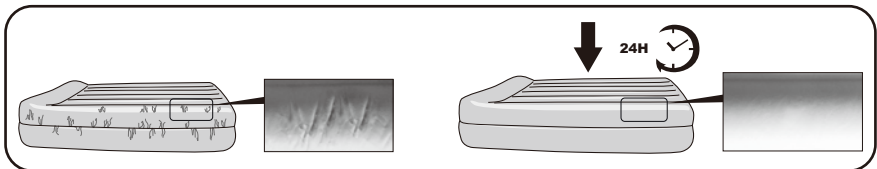

DEFLATION

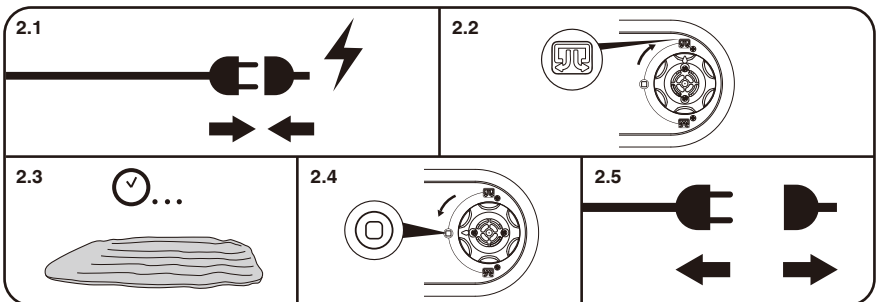

CLEANING AND MAINTENANCE

- Do not use harsh detergents to clean.

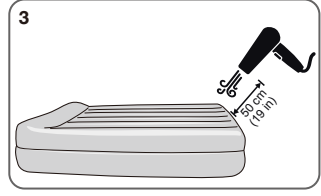
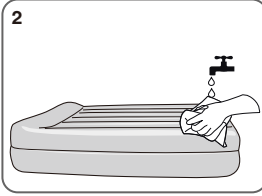
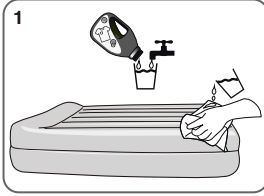

STORAGE

- Fold and store after product is dried. Deflate the airbed following the "DEFLATION" instructions.
- Make sure all the air inside is removed and the air mattress surface is completely dried. Follow these steps to fold and store the mattress.
- Place the mattress in its storage bag and store in a dry location with a temperature above 59°F, away from chemicals and heavy or sharp objects.

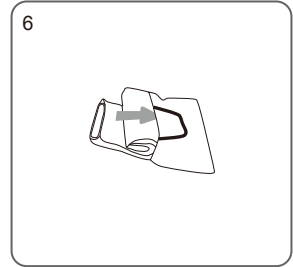
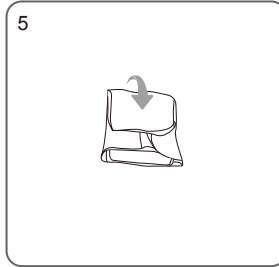
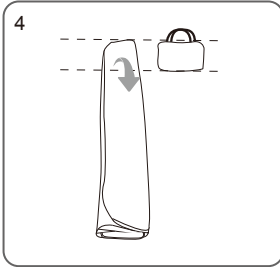
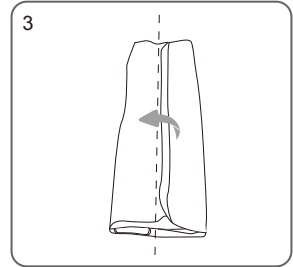
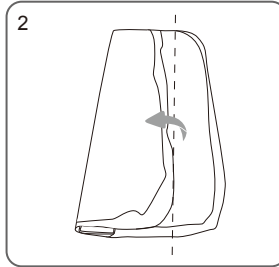
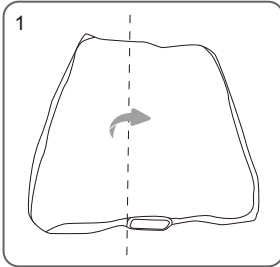

REPAIR

- Fully clean the area to be repaired.
- Cut the correct size from the repair patch material.
- Only apply the amount of glue (not included) needed to cover the repair site.
- Press the repair patch firmly to the repair site for 30 seconds.
- Wait for 1 hour before inflation.