



OWNER'S MANUAL

Built-in Sidewinder™ P3150 AC Electric Pump

©2022 Bestway Inflatables & Material Corp.

All rights reserved

Trademarks used in some countries under license from **Bestway Inflatables & Material Corp., Shanghai, China**

Exported by **Bestway (Hong Kong) International Ltd./Bestway Enterprise Company Limited**

Suite 713, 7/Floor, East Wing, Tsim Sha Tsui Centre, 66 Mody Road, Kowloon, Hong Kong

Distributed in North America by **Bestway (USA) Inc., 3435 S. McQueen Road, Chandler, AZ 85286, United States of America**

Tel: +86 21 69135588

www.bestwayusa.com

IMPORTANT SAFETY INSTRUCTIONS

READ AND FOLLOW ALL INSTRUCTIONS.

Carefully read, understand, and follow all information in this user manual before installing and using the air mattress.

These warnings, instructions, and safety guidelines address some common risks, but they cannot cover all risks and dangers in all cases. Always use caution, common sense, and good judgement when enjoying the air mattress. Retain this information for future use. In addition, the following information can be supplied depending on the air mattress type. Safekeeping the instruction. If instruction is missing, search it on the website. www.bestwayusa.com/support

FOR INDOOR USE ONLY.
HOUSEHOLD USE ONLY.

WARNING

- This appliance has a polarized plug (one blade is wider than the other). To reduce the risk of electric shock, this plug is intended to fit in a polarized outlet only one way, if the plug does not fit fully in the outlet, reverse the plug, if it still does not fit, contact a qualified electrician. Do not attempt to defeat this safety feature.
- Motor run time should not exceed 5 minutes. Operator should allow motor to cool for 5 minutes between uses.
- Product must be stored in a dry location.
- Infants have suffocated on inflatable mattresses. Never place infant aged birth to 15 months to sleep on this inflatable air mattress/air bed. Infants can suffocate on an underinflated or deflated mattress, on bedding, by co-sleeping with another person, and by entrapment between the mattress and bed frame or between the mattress and a vertical surface.
- Children can be entrapped between the inflatable mattress and an adjacent vertical surface. Provide at least a shoulder width space between the inflatable mattress/airbed and adjacent vertical surfaces such as walls, dressers, or other objects.
- Always keep the inflatable mattress fully inflated when in use.

TECHNICAL INSTRUCTIONS

DUAL FUNCTION: INFLATION & DEFLATION EXCLUSIVELY DESIGNED FOR AIR BEDS.
READ CAREFULLY BEFORE OPERATING AND SAVE THESE INSTRUCTIONS.

TO AVOID THE RISK OF ELECTRIC SHOCK, DO NOT EXPOSE TO WATER OR RAIN.

- Unplug or disconnect the appliance from the power supply before using and servicing.
- The air vent on the cover should be kept free of debris during use.
- Product must be stored in a dry location.
- After use, airbeds may require additional air to increase firmness. Add air to proper firmness.
- This product is not intended for commercial use.
- Drawings for illustration purpose only. May not reflect actual product. Not to scale.

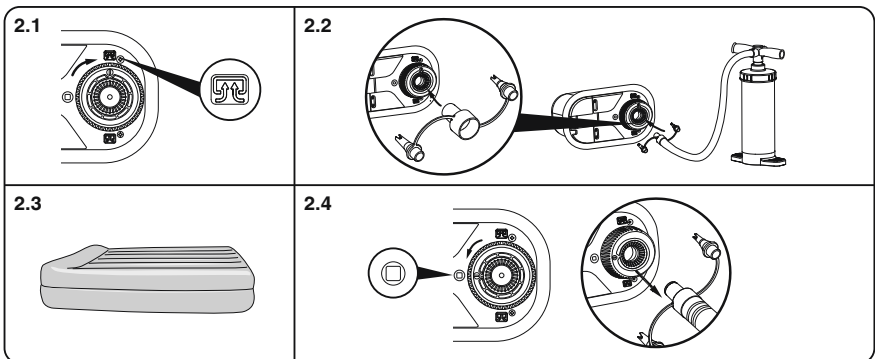
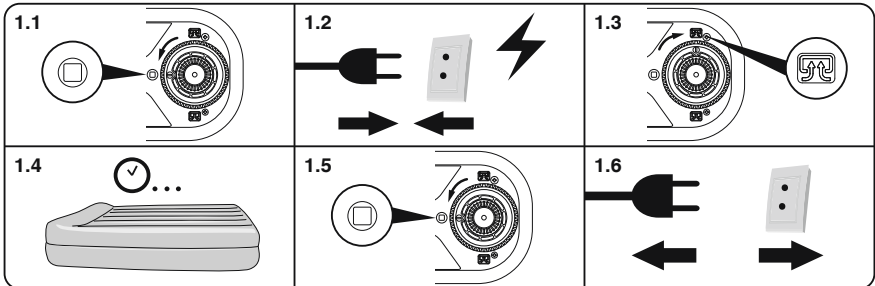
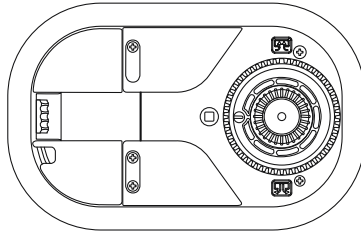



3.1

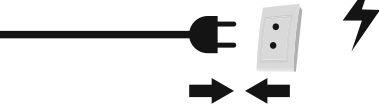

3.2

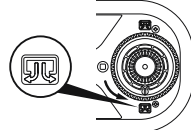

3.3



3.4

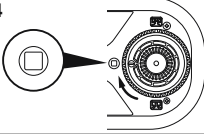

3.5

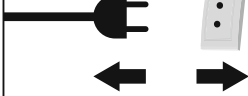

4.1

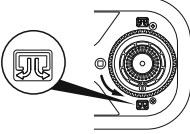

4.2

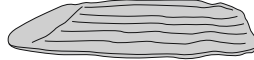

5.1

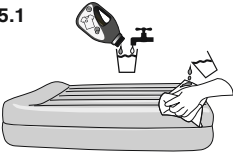

5.2

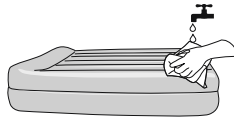

5.3

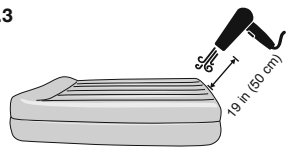

59°F

6.1

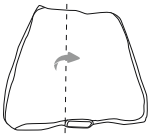

6.2



6.3



6.4

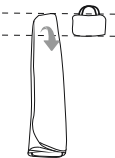

6.5



6.6

