

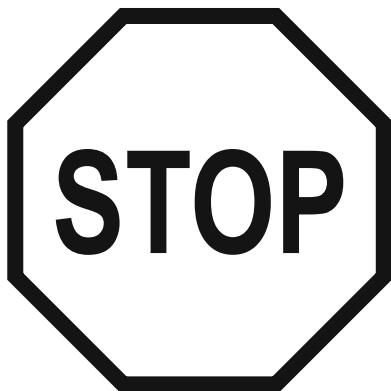

**90508E 90524E 90363E**  
**110-120V~ 60Hz, 12A at 68°F (20°C)**  
**Coleman**  
**OWNER'S MANUAL**



**DO NOT RETURN THIS ITEM TO THE STORE OR  
WEBSITE WHERE IT WAS PURCHASED.  
PLEASE VISIT [BESTWAYUSA.COM/SUPPORT](http://BESTWAYUSA.COM/SUPPORT)  
FOR QUESTIONS, OR FOR DEFECTIVE OR  
WARRANTY CLAIMS.**

# OWNER'S MANUAL

S100105/S100205



Visit the Bestway  
YouTube channel



## CONTENTS

<b>IMPORTANT SAFETY INSTRUCTIONS</b>	<b>PG 002</b>
<b>PRE-SETUP</b>	<b>PG 009</b>
<b>INSTALLATION</b>	<b>PG 012</b>
<b>USING THE SPA</b>	<b>PG 012</b>
<b>MAINTENANCE</b>	<b>PG 014</b>
<b>DISASSEMBLY AND STORAGE</b>	<b>PG 014</b>
<b>TROUBLESHOOTING</b>	<b>PG 015</b>
<b>ERROR CODES</b>	<b>PG 017</b>

## IMPORTANT SAFETY INSTRUCTIONS

**READ AND FOLLOW ALL INSTRUCTIONS.**

Carefully read, understand, and follow all information in this user manual before installing and using the spa. These warnings, instructions, and safety guidelines address some common risks of water recreation, but they cannot cover all risks and dangers in all cases. Always use caution, common sense, and good judgment when enjoying any water activity. Retain this information for future use. In addition, the following information can be supplied depending on the spa type. Keep these instructions in a safe place. If instructions are missing, please contact the manufacturer or search it on the website [www.bestwayusa.com](http://www.bestwayusa.com).

# WARNING

## IMPORTANT SAFETY INSTRUCTIONS

When using this electrical equipment, basic safety precautions should always be followed, including the following:

### READ AND FOLLOW ALL INSTRUCTIONS.

**WARNING** - To reduce the risk of injury, do not permit children to use this product unless they are closely supervised at all times.

A wire connector is provided on this unit to connect a minimum 8 AWG (8.37 mm<sup>2</sup>) solid copper conductor between this unit and any metal equipment, metal enclosures of electrical equipment, metal water pipe, or conduit within 5 feet (1.5 m) of the unit.

**DANGER** - Risk of injury.

- Replace damaged cord immediately.
- Do not bury cord.
- Connect to a grounded, grounding type receptacle only.

**WARNING** - This product is provided with a ground-fault circuit-interrupter integrated with the power plug at the end of the cord. The GFCI must be tested before each use. With the product operating, push the test button on the GFCI and the product should not operate. Push the reset button on the GFCI and the product should now operate normally. When the product fails to operate in this manner, there is a ground current flowing indicating the possibility of an electrical shock. Disconnect the power until the fault has been identified and corrected.

**DANGER** - Risk of Accidental Drowning. Extreme caution must be exercised to prevent unauthorized access by children. To avoid accidents, ensure that children cannot use this spa unless they are supervised at all times.

**DANGER** - Risk of Injury. The suction fittings in this spa are sized to match the specific water flow created by the pump. Should the need arise to replace the suction fittings or the pump, be sure that the flow rates are compatible. Never operate spa if the suction fittings are broken or missing. Never replace a suction fitting with one rated less than the flow rate marked on the original suction fitting.

**DANGER** - Risk of Electric Shock. Install at least 5 feet (1.5 m) from all metal surfaces. As an alternative, a spa may be installed within 5 feet of metal surfaces if each metal surface is permanently connected by a minimum 8 AWG (8.37 mm<sup>2</sup>) solid copper conductor to the wire connector on the terminal box that is provided for this purpose.

**DANGER** - Risk of Electric Shock. Do not permit any electric appliance, such as a light, telephone, radio, or television, within 5 feet (1.5 m) of a spa.

**WARNING** - To reduce the risk of injury:

- The water in a spa should never exceed 104°F (40°C). Water temperatures between 100°F (38°C) and 104°F (40°C) are considered safe for a healthy adult. Lower water temperatures are recommended for young children and when spa use exceeds 10 minutes.
- Since excessive water temperatures have a high potential for causing fetal damage during the early months of pregnancy, pregnant or possibly pregnant women should limit spa water temperatures to 100°F (38°C).
- Before entering a spa, the user should measure the water temperature with an accurate thermometer since the tolerance of water temperature-regulating devices varies.
- The use of alcohol, drugs, or medication before or during spa use may lead to unconsciousness with the possibility of drowning.
- Obese persons and persons with a history of heart disease, low or high blood pressure, circulatory system problems, or diabetes should consult a physician before using a spa.

f) Persons using medication should consult a physician before using a spa since some medication may induce drowsiness while other medication may affect heart rate, blood pressure, and circulation.

**WARNING:** To avoid electric shock, do not use the spa during storms in case of thundering or lighting. In case of rain always keeping plug dry, plug in with wet plug is definitely forbidden.

Hyperthermia occurs when the internal temperature of the body reaches a level several degrees above the normal body temperature of 98.6°F (37°C). The symptoms of hyperthermia include an increase in the internal temperature of the body, dizziness, lethargy, drowsiness, and fainting. The effects of hyperthermia include failure to perceive heat, failure to recognize the need to exit spa or hot tub, unawareness of impending hazard, fetal damage in pregnant women, physical inability to exit the spa or hot tub, and unconsciousness resulting in the danger of drowning.

**WARNING:** The use of alcohol, drugs, or medication can greatly increase the risk of fatal hyperthermia.

**WARNING:** Water attracts children; Always attach a spa cover after each use.

**WARNING:** TO REDUCE THE RISK OF INJURY: Never add water that is higher than 104°F (40°C) into the spa.

## CONSULT YOUR PHYSICIAN FOR RECOMMENDATIONS. CAUTION:

We strongly recommend not to unfold and inflate the spa if the ambient temperature is below 59°F(15°C). We suggest inflating the spa indoors, and then continuing set up outdoors. If the outdoor temperature is lower than 42.8°F(6°C), the spa heater must always be on. In this mode, the Freeze Shield™ system can keep the internal temperature between 42.8°F(6°C) and 50°F(10°C) to prevent damage, such as water freezing in the pipes or the circulation system.

**IMPORTANT:** If the Freeze Shield™ system isn't working, alarms will pop up on the spa. Be sure to check the status of your spa if the outdoor temperature is below 42.8°F(6°C). In case of a long-term absence from home when there is a risk of temperatures falling below 42.8°F(6°C), we strongly suggest disassembling the spa and storing it following the storage procedure.

**CAUTION:** Do not use the spa alone.

**CAUTION:** Always enter and exit the spa slowly and cautiously. Wet surfaces are slippery.

**CAUTION:** To avoid damage to the pump, the spa must never be operated unless the spa is filled with water.

**CAUTION:** Immediately leave spa if the user feels uncomfortable or sleepy.

**NOTE:** Please examine equipment before use. Notify Bestway® at the customer service address listed on this manual for any damaged or missing parts at the time of purchase. Verify that the equipment components represent the model that you had intended to purchase.

This device complies with part 15 of the FCC Rules. Operation is subject to the following two conditions: (1) This device may not cause harmful interference, and (2) this device must accept any interference received, including interference that may cause undesired operation.

Any changes or modifications to this unit not expressly approved by the party responsible for compliance could void the user's authority to operate the equipment.

**NOTE:** This equipment has been tested and found to comply with the limits for a Class B digital device, pursuant to part 15 of the FCC Rules. These limits are designed to provide reasonable protection against harmful interference in a residential installation. This equipment generates, uses and can radiate radio frequency energy and, if not installed and used in accordance with the instructions,

may cause harmful interference to radio communications. However, there is no guarantee that interference will not occur in a particular installation. If this equipment does cause harmful interference to radio or television reception, which can be determined by turning the equipment off and on, the user is encouraged to try to correct the interference by one or more of the following measures:

- Reorient or relocate the receiving antenna.
- Increase the separation between the equipment and receiver.
- Connect the equipment into an outlet on a circuit different from that to which the receiver is connected.
- Consult the dealer or an experienced radio/TV technician for help.

Changes or modifications not expressly approved by the party responsible for compliance could void the user's authority to operate the equipment.

To satisfy FCC / IC RF exposure requirements, a separation distance of 20 cm or more should be maintained between the antenna of this device and persons during device operation.

To ensure compliance, operations at closer than this distance is not recommended. Limited by local law regulations, version for North America does not have region selection option.

**ASSEMBLY: THE PROVIDED WARNING LABEL**

 <b>WARNING</b>
<b>REDUCE THE RISK OF ELECTROCUTION</b> 1. NEVER PLACE AN ELECTRIC APPLIANCE WITHIN 5 FEET OF SPA.
<b>REDUCE THE RISK OF CHILD DROWNING</b> 1. SUPERVISE CHILDREN AT ALL TIMES. 2. ATTACH SPA COVER AFTER EACH USE.
<b>REDUCE THE RISK OF OVERHEATING</b> 1. CHECK WITH A DOCTOR BEFORE USE IF PREGNANT, DIABETIC, IN POOR HEALTH, OR UNDER MEDICAL CARE. 2. EXIT IMMEDIATELY IF UNCOMFORTABLE, DIZZY, OR SLEEPY. SPA HEAT CAN CAUSE HYPERTHERMIA AND UNCONSCIOUSNESS. 3. SPA HEAT IN CONJUNCTION WITH ALCOHOL, DRUGS, OR MEDICATION CAN CAUSE UNCONSCIOUSNESS.
<b>WHEN PREGNANT, SOAKING IN HOT WATER FOR LONG PERIODS CAN HARM YOUR FETUS. MEASURE WATER TEMPERATURE BEFORE ENTERING.</b> 1. DO NOT ENTER SPA IF WATER IS HOTTER THAN 100°F(38°C) 2. DO NOT STAY IN SPA FOR LONGER THAN 10 MINUTES.

**NOTE:** The warning label must be posted near your spa in a readable position during using your spa.

1. Take out the warning label from the accessory kit.
2. Carefully peel the warning label.
3. Affix the warning label.

To order the warning label, please contact your local Bestway After Sales Service.

# Supplier's Declaration of Conformity

Under FCC Part 15 SDoC Procedure

Product Description : SPA

Model Number : S100105 / S100205

Trade Name : Bestway

Responsible Party in USA : Bestway (USA) Inc.  
3435 S. McQueen Road, Chandler, AZ 85286,  
United States of America

Testing Laboratory : Intertek Testing Services Shanghai  
Building No.86, 1198 Qinzhou Road (North),Caohejing  
Development Zone, Shanghai 200233, China

Addendum to the Test Report : 200101172SHA-001 / 191102629SHA

## FCC Compliance Statement

This device complies with part 15 of the FCC Rules. Operation is subject to the following two conditions: (1) This device may not cause harmful interference, and (2) this device must accept any interference received, including interference that may cause undesired operation.

For and on behalf  
of Responsible Party



Mi Huang

info@bestwaycorp.us

# SPA SUCTION FITTING INSTRUCTIONS

When installing and using this equipment, basic safety precautions shall always be followed, including the following:

## IMPORTANT SAFETY INSTRUCTIONS READ, FOLLOW, AND UNDERSTAND ALL INSTRUCTIONS AND WARNINGS.

- Any modification that increases the flow rate of the circulation system shall require re-evaluation of the cover/grate and sump to ensure that the flow rating of the Suction Outlet Fitting Assembly (SOFA) is not exceeded.
  - Missing, broken, or cracked cover/grates, sumps, mud-frames, or any other SOFA component shall be replaced before bathers are allowed to use the pool.
  - Loose cover/grates shall be reattached before bathers are allowed to use the pool.
1. Replace suction fittings every 3 years.
  2. The use of adhesives or other attachment methods that prevent access to suction piping or SOFA components requiring periodic servicing is prohibited.
  3. Refer to the following diagram for each SOFA component part instructions:

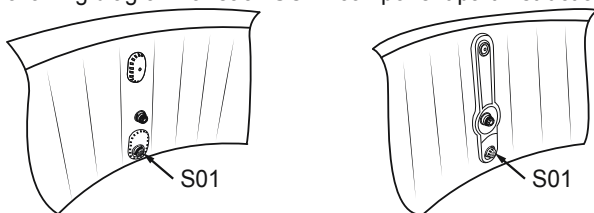

### Only for Fortifiber Spa

4. Any field modification made to a SOFA not authorized by the manufacturer's installation instructions shall void the SOFA certification.
  - No modification shall be made to a SOFA structure or flow path unless the new configuration has been certified as new SOFA.
  - Cover/grates and all other SOFA components shall be replaced at or before the end of their service life and that service life begins the month and year in which a SOFA component is installed with or without water.
5. Winterizing instructions. Dry the suction fittings completely, and store the product in a dry room at a storage temperature of 59°F~104°F(15°C~40°C).
  - Cover/grate, including fasteners, shall be observed for damage or tampering each operational day.
  - Missing, broken, or cracked cover/grates shall be replaced before bathers are allowed to use the pool.
  - Loose cover/grates and associated components shall be reattached before bathers are allowed to use the pool.
  - SOFA components and fastener receptacles shall be clean and free of debris or obstructions during installation of cover/grate and fasteners.
  - Remember to hand-check cover/grate for snugness to the sump/ frame after installation.
6. Before using the product, please check the integrity of the head of the suction fitting. If the product is broken, cracked, or the color has significantly faded, please do not use it.
7. All SOFAs shall be installed in accordance with the manufacturer's installation instructions.
  - No modification shall be made to a SOFA structure or flow path unless the new configuration has been certified to the original SOFA.

- These SOFA-configuration specific flow ratings NOT be exceeded at any time the pool is open to bathers.
- Cover/grates, when installed, shall not protrude more than 2 in. (51 mm) from the finished surface of the pool in which the SOFA is installed.

8. 

<p>Installation Information label (Copy)  Manufacturers name: Bestway (Nantong) Recreation Corp.  Cover part number: S01  Life expectancy: 3 Years  Cover flow rating: 20 GPM  Configuration and installed orientation: Wall  Location: Spa Pool liner  Date of installation: _____  Installer needs to fill in the balance of the information and permanently post it as near as feasible to the pump control. Keep a copy of this information with the other important pool related documents.</p>
--

Please research and download General Certificate of Conformity through [www.bestwayusa.com](http://www.bestwayusa.com)

## GFCI WARNING

**IMPORTANT:** RISK OF ELECTRIC SHOCK. THE GFCI MUST BE TESTED BEFORE TURNING ON THE PUMP EACH TIME.

**WARNING:** The GFCI plug must be tested before each use to avoid risk of electric shock.

**WARNING:** Before inserting plug into a power outlet, make sure the current rate of the power outlet is suitable for the pump.

**WARNING:** Do not use the pump if this test fails. For assistance, please visit the support section on our website, [www.bestwayusa.com](http://www.bestwayusa.com).

**WARNING:** The spa is a class I electrical appliance and must be connected directly to a grounded socket. It is recommended to only use a socket which is resistant to humidity and capable of high power loading. Regularly check the plug and socket for signs of damage before using the spa – do not use the spa if the plug or socket is damaged. If you are unsure about the quality of the electrical supply, please consult a qualified electrician before use.

## SAVE THESE INSTRUCTIONS



# PRE-SETUP

---

## CHECK LIST

To check the parts printed inside the manual, verify that the equipment components represent the model that you had intended to purchase. In case of any damaged or missing parts at the time of purchase, visit our website [bestwayusa.com/support](http://bestwayusa.com/support).

## CHOOSE THE CORRECT LOCATION

Indoor and outdoor & above ground & portable wiring & portable spa.

### **Only For Spas Equipped With Wi-Fi:**

To choose the correct location for the spa equipped with Wi-Fi, read the Spa Wi-Fi instruction leaflet included in the package and the following instructions.

### **For All Spas:**

The surface chosen to install the pool must respect the following technical characteristics.

- Because of the combined weight of the water inside the spa and the users, it is extremely important that the surface chosen to install the spa is capable of uniformly supporting the total weight for the entire time the spa is installed.
- An adequate drainage system has to be provided to deal with overflow water for both indoor and outdoor installations. During filling, draining or when in use, water may flow out of the spa.
- The surface must be flat and smooth. If the surface is inclined or uneven, it can create an unbalanced loading on the structure of the spa. This situation can damage the welding point.
- The selected surface must be clear of any type of object. Due to the weight of the water, any object under the spa could damage or perforate the bottom of the spa.

- The selected location must not have overhead power lines or trees. Be sure the location does not contain underground utility pipes, lines or cables of any kind.
- The selected position must be far from the house entrance. Do not position any equipment or other furniture around the spa. The water that comes out of the spa during the use or due to a faulty product can damage the furniture inside the house or surrounding the pool.
- Do not to install the spa on carpet or other floor materials (e.g. untreated cork, timber or other porous materials) that promote or harbor moisture and bacteria, or that could be affected by water treatment chemicals used in the spa.
- Consult your local government authority for installation regulations.

**Suggested set-up surfaces:** grass, ground, concrete, and all other surfaces that respect the above set-up conditions.

**Not suggested surfaces:** mud, sand, gravel, deck, balcony, driveway, platform, soft/loose soil or other surface that does not meet the above set-up conditions.

### **Indoor Installation:**

**Be aware of special requirements if you install the spa indoors.**

- Humidity is a natural side effect with SaluSpa installation. Determine the effects of airborne moisture on exposed wood, paper, etc. in the proposed location. To minimize these effects, it is strongly recommended to provide plenty of ventilation to the selected area. Consult an expert to determine if more ventilation is needed.
- Keep suitable air treatment in the indoor location (ventilation and dehumidification) regularly to preserve the bathers' safety and comfort.
- Empty the spa before removing it from the indoor location or building.

## **Outdoor Installation:**

- The selected surface must be clear of aggressive plants and weed species. Those types of strong vegetation could grow through the liner and create water or air leakage. The grass or other vegetation that may cause odor or slime to develop have to be eliminated from the set-up location.
- Do not leave the spa's surface exposed to direct sunlight for long periods of time. We recommend protecting the spa from direct sun light exposure by a cover when not in use.
- Follow the important instructions above to choose the correct surface and location to set up your spa. Damaged parts of the spa, due to the fact that the set-up surface and location does not match the instructions, will not be considered as manufacture defect and will avoid the warranty and any service claims. It is the responsibility of the owner to ensure the site meets the requirements at all times.
- Consult your local professional installers for environmental conditions, such as ground water and risk of frost.

# INSTALLATION

For the installation instructions, follow the drawings printed inside the manual. Drawings are for illustration purposes only. May not reflect actual product. Not to scale.

## RECOMMENDATIONS DURING THE INSTALLATION

- Use of an extension cord or multi-plug adaptor with the spa heater is dangerous and can cause the plug to overheat, causing damage to the equipment and surrounding items.
- Keep the spa away from the rest area to minimize noise disturbance.
- Keep at least 1m clearance around the spa.
- We don't recommend using sea water to fill the pool. Sea water can corrode the internal metal components due to the high concentration of salt.
- The filtration system of the spa is designed to be used only with the filter cartridge. Any other component added inside the filter set can cause damage to the filtration system of the spa. This will not be covered by customer service.

## INFLATION INFORMATION

### Only For Inflatable Spa Liner or Inflatable Cover:

- When inflating, you will notice that air will be expelled from the area where the air hose connects to the pump, this is normal for technique requirements.
- Don't cover the holes on the base of the inflation hose, the inflation hose is designed to inflate the spa to the correct pressure. This operation will over inflate the liner and damage the structure.
- Do not use an air compressor to inflate the spa.
- Do not drag the pool on rough ground as this may cause damage to the spa liner. Inflation time for reference only.

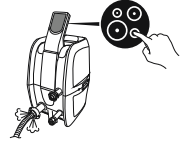

## HAND PUMP PRESSURE GAUGE

### Only For Fortifiber Spa:

- The air pressure gauge of the hand pump only shows the air pressure higher than 5 psi, which is normal. When the air pressure in the product is lower than 5 psi, the air pressure gauge will not show a value.

## AIR VALVE CHECK

### Only For Fortifiber Spa:

- If the air valve is loose, use the provided wrench to fasten the air valve following these steps: With one hand, hold the backside of the air valve from the inner side of the spa wall and turn the wrench clockwise.
- Do not adjust the air valve connector when the spa is in use.

# USING THE SPA



## CONTROL PANEL





**LOCK/UNLOCK BUTTON:** The pump has a 5-minute auto-lock, this light will turn on. To lock or unlock the pump, press the lock/unlock button for 2 seconds.





**POWER-SAVING TIMER BUTTON:** Designed to help avoid wasting power by setting the time and duration of the heating cycle for the spa. follow these steps to activate the POWER-SAVING function.



Press the  button and the  LED starts to flash.



Press the  or  button to adjust the heating duration (From 1-999 hours).

Press the  button again to confirm the heating duration.

After setting the heating duration, the  LED starts to flash.

Press the  or  button to set the time (From 0-999 hours). This setting defines the waiting hours before the activation of the heating function. If the timer is set to 0 hour, the heating system will activate immediately.

Press  button again or simply touch nothing for 10 seconds to confirm the setting. The  LED will light steadily, and the countdown to heater activation will begin. The screen flashes the current temperature and time alternately.



To modify the timer settings: Press the  button and use the  or  button to adjust.

Cancel the setting: Press the  button for 2 seconds.

When the power saving function is activated, all other functions (massage, filtration) except the heating can be used.

The POWER-SAVING function in not an automatic function: after one complete cycle (waiting time plus heating function), this function must set again.



**HEAT BUTTON:** Press  button to activate the heating system. When the light of the  button is red, the heating system is activated. When the light is green, the water reached the set temperature.

If the heating system is activated, the filtration system will automatically start.

After turning off the heating system, the filtration system will continue to operate.



**MASSAGE SYSTEM BUTTON:** Press  button to activate the massage system, which has a 30-minute auto-shutoff feature. The light of the button becomes red when activated.





Do not run the massage system when the cover is attached, air can accumulate inside the spa and cause irreparable damage to the cover. Heat and massage system can be activated at the same time.

## FOR SPA EQUIPPED WITH WI-FI ONLY

**2-LEVEL MESSAGE REGULATION:** Push once for the full power massage; the display will show L1. Push it again for a lower power massage; the display will show L2. Push it a third time to shut the massage function off.

When inflating the spa liner, make sure that the massage function is running at full power.





**TEMPERATURE ADJUSTMENT BUTTONS:** Pressing the  or  button, the display starts to flash showing the set temperature for 3 seconds, after that it will show again to the real water temperature. When it is flashing you can adjust the temperature using the  or  button.



The default temperature is 35°C (95°F). Temperature adjustment ranges from 20°C (68°F) to 40°C (104°F).



**ON/OFF BUTTON:** After activating the GFCI, press and hold the  button for 2 seconds. The  button turns to green and the control panel is activated. Press and hold  button for 2 seconds to turn off all currently activated functions.



**CELSIUS/FAHRENHEIT TOGGLE:** The temperature can be displayed in either Fahrenheit or Celsius.



**WATER FILTER BUTTON:** The  button turns the filter pump on and off. The  button turns to red when activated.



**FOR SPA EQUIPPED WITH WI-FI ONLY**  
**WI-FI ACTIVATION:** For the Wi-Fi operation instruction, read the spa Wi-Fi instruction leaflet included in the package.

**The WATER HEATER rate may change in the conditions below:**

- When the outdoor temperature is below 15°C (59°F).
- If the cover is not in position. Always keep the spa cover on when the spa is not in use; it avoids dust contaminating the water and it minimizes heat loss.
- The water temperature shown on the display may not be correct, if the filtration system is not activated. To read the correct water temperature on the display, run the filtration system for at least a minute.
- The water temperature as tested by an external thermometer may vary from the temperature as displayed on the spa panel by as much as approximately 2°C (3.6°F).



## WINTER USE INSTRUCTIONS

**It is important to follow these suggestions if you are setting up the spa during the winter period. This will prevent any damage to the spa heater and material of the liner, extending the life of your product drastically.**

- If the outdoor temperature is below 10°C (50°F), to avoid any damage to spa liner, keep the package indoors where the temperature is above 15°C (59°F). This will make the spa liner more flexible and easier to set up.
- Open the package and inflate the spa liner using the spa heater in a room where the temperature is above 15°C (59°F).
- Position the spa liner outdoors in the desired position, then connect the spa heater and fill with water. The water temperature used to fill the spa must be above 6°C (42.8°F), otherwise when you begin to operate with the spa heater, the E03 alarm will appear.
- You can keep the spa on during winter when the temperature is lower than 6°C (42.8°F). The Freeze Shield™ system automatically keeps the water temperature between 6°C (42.8°F) and 10°C (50°F), and it will prevent the water from freezing.
- If the water temperature is below 6°C (42.8°F), the spa heater must always be on. In this mode, the Freeze Shield™ system can keep the internal temperature between 6°C (42.8°F) and 10°C (50°F) to prevent damage, such as water freezing in the pipes or the circulation system.
- If any alarms appear on the display, the Freeze Shield™ system isn't working. Be sure to check the status of your spa if the outdoor temperature is below 6°C (42.8°F). In case of a long-term absence from home when there is a risk of temperatures falling below 6°C (42.8°F), we strongly suggest disassembling the spa and storing it following the storage procedure.
- Any damage as a result of using the spa in these conditions is the responsibility of the customer. Do not use the spa when the ambient temperature reaches -10°C (14°F).

### HEATING TIME

- To reach 40°C (104°F), the heating duration required is based on the starting water temperature and ambient temperature, the data below is purely for reference. To display the current water temperature, run the filter system for at least a minute.

Ambient Temperature	Water Temperature	Set Temperature	Heating Duration
10°C (50°F)	10°C (50°F)	40°C (104°F)	23-40h
15°C (59°F)	15°C (59°F)	40°C (104°F)	18-36h
20°C (68°F)	20°C (68°F)	40°C (104°F)	13-29h
25°C (77°F)	25°C (77°F)	40°C (104°F)	9-20h
30°C (86°F)	30°C (86°F)	40°C (104°F)	7-15h

- We do not recommend setting up the spa, filling it and heating it for the first time when the outdoor ambient temperature is below 10°C (50°F) as it will take a very long time to heat.
- To reach and maintain maximum water temperature of 40°C (104°F), outdoor temperature must not be lower than -5°C (23°F).
- Do not operate the spa below -10°C (14°F).
- Be sure to cover the spa with the spa cover whenever the heating function is activated. Leaving the spa uncovered will increase the heating duration required. When the spa is assembled with water, do not switch off the spa heater if the temperature is lower than 6°C (42.8°F).

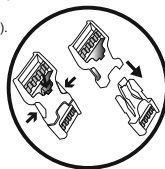

## SPA HEATER SPECIFICATION

Power Rate	Massage Tube Blower	Heat Element	Water Pump
110-120V AC, 60Hz, Single Phase 12A at 20°C	6.5A	11.3A at 20°C	0.7A

# MAINTENANCE

**CAUTION:** You must ensure the pump is unplugged before beginning spa maintenance to avoid risk of injury or death.

## LINER

- It is normal that your spa liner may appear as if it is losing air. Changes in ambient temperature may change the internal air pressure in the liner.
- When detaching the pump from the liner, to avoid water coming out from the pipes, block the air pipe by screwing on the cap and installing the stoppers on the debris screens.

## COVER

- The cover shall be cleaned inside and outside periodically, using a gentle detergent for the PVC material.

## FILTER CARTRIDGE

- To optimize the performance of the filtration system, check and clean your filter cartridge every day.
- We recommend changing your filter cartridge every week or replacing it if after washing, the filter cartridge remains soiled and discolored.

## WATER

Many pollutants in the water settle on surfaces below the water line. These pollutants can cause bacterial, algal or fungal growth. It is recommended that spas are cleaned as regularly as necessary. After a time, tenacious stains or biofilms may develop on the accessible surfaces below the water line or high concentrations of salts or unwanted reaction by-products may also occur. Depending on hygienic condition, cleanliness, visibility, odour, debris and stains, it is recommended to change the water completely and clean/disinfect the spa. When emptying the spa, the regulations and the instructions for draining the water shall be observed.

- Keeping your spa water clean and chemically balanced is necessary. Simply cleaning the filter cartridge is not enough for proper maintenance, we recommend using pool chemicals to maintain water chemistry and chlorine or bromine tablets (do not use granules) with the chemical dispenser.
- Water quality will be directly related to frequency of use, number of users and overall maintenance of the spa. The water should be changed every 3 days if there is no chemical treatment being performed with the water. It is highly recommended to use tap water for spa filling to minimize the influence of unwanted contents, such as minerals.
- We recommend you take a shower before using your SaluSpa, as cosmetic products, lotions, and other residues on the skin can quickly degrade water quality.
- Don't throw chemical products directly in the water; the chemical will deposit on the bottom of the spa and damage the material and discolor the PVC.

### Chemical Tablets (Not Included):

- Remove the chemical dispenser from spa when the spa is in use.
- After performing chemical maintenance and before using the spa, use a test kit (not included) to test the water chemistry. We recommend maintaining your water chemical balance as the following:
- Spa damage resulting from misuse of chemicals and mismanagement of spa water is not covered by the warranty.
- Pool chemicals are potentially toxic and should be handled with care. There are serious health risks from chemical vapors and the incorrect labeling and storage of chemical containers.
- Please consult your local pool or chemical supply retailer for more information about chemical maintenance. Pay close attention to the chemical manufacturer's instructions.
- Over usage of chemicals will discolor the printing and all points of the spa material; in the worst case, it will damage the structure of the spa liner.

pH	Total Alkalinity	Free Chlorine
7.4-7.6	80-120ppm	2-4ppm

# DISASSEMBLY AND STORAGE

## DRAINING

- To drain the spa, follow the drawings inside the manual. Drawings are for illustration purposes only. May not reflect actual product. Not to scale.

## DRYING

- After draining the spa, some water remains inside the spa pump, liner chamber, massage chain and inflatable cover. Make sure that all above parts of spa are completely dry. This is essential to extend the life of the spa and to avoid creation of mildew.
- The water inside the liner chamber and the inflatable cover come from the humidity in the air used to inflate them. The quantity of water may vary depending on the percentage of humidity in your area.
- To dry the different parts of the spa, follow the drawings inside the manual. Drawings are for illustration purposes only. May not reflect actual product. Not to scale.

## CLEANING

- Detergent residues and dissolved solids from bathing suits and chemicals may build up on the spa walls. Use soap and water to clean the walls and rinse thoroughly. Do not use hard brushes or abrasive cleaners.

## DEFLATING

### Only For Inflatable Spas:

- Your spa is equipped with a deflation function to remove all the air from inside the chamber to make it easier to pack and store.
- To deflate the spa, follow the drawings inside the manual. Drawings are for illustration purposes only. May not reflect actual product. Not to scale.

## REPAIRING

### For PVC Material:

**If the spa is torn or punctured, use the provided PVC repair patch and follow the below steps:**

- Clean the area to be repaired. Carefully peel patch.
- Press patch over the area to be repaired.
- Wait 30 seconds before inflation.

### For Duraplus™ PVC Material:

**If the spa is torn or punctured, use the provided PVC patch and glue (not included) and follow the below steps:**

- Clean and dry the area to be repaired.
- Cut the provided PVC patch to appropriate size.
- Use glue (not included) to coat the one side of the newly cut patch. Make sure the glue is evenly distributed. Wait for 30 seconds and then place the cut patch with glue over the damaged area.
- Smooth out any bubbles of air that may be trapped underneath, and press firmly for two minutes.
- Wait 30 minutes before inflation.

## STORAGE

- Remove all accessories and make sure that spa liner, inflatable cover, pump and accessories are completely clean and dry before storing. If spa is not completely dry, mold may result and will damage the spa liner during the storage period.
- Fold the spa liner only if the environment temperature is above 10°C (50°F). If spa is not completely dry, mold may result and will damage the pool liner.
- Store the spa in a dry place with a moderate temperature between 10°C (50°F) and 38°C (100°F).
- We strongly recommend positioning the spa liner and inflatable cover inside a carton box, to better protect the PVC material during winter months.

# TROUBLESHOOTING

Problems	Probable Causes	Solutions
Pump does not operate	<ul style="list-style-type: none"> <li>- Power failure</li> <li>- Power circuits is broken</li> </ul>	<ul style="list-style-type: none"> <li>- Check power source</li> <li>- For assistance, please visit the support section on our website, <a href="http://www.bestwayusa.com">www.bestwayusa.com</a></li> </ul>
Pump does not heat properly with lid	<ul style="list-style-type: none"> <li>- Temperature set too low</li> <li>- Dirty filter cartridge</li> <li>- Spa is not covered with lid.</li> <li>- Heating element failed</li> </ul>	<ul style="list-style-type: none"> <li>- Set spa to a higher temperature; refer to pump operation section</li> <li>- Clean/replace the filter cartridge; refer to section filter cartridge cleaning and replacement section</li> <li>- Attach the cover</li> <li>- For assistance, please visit the support section on our website, <a href="http://www.bestwayusa.com">www.bestwayusa.com</a></li> </ul>
Massage System does not work	<ul style="list-style-type: none"> <li>- Air pump is overheating</li> <li>- The massage stops automatically after 30 minutes.</li> <li>- Air pump is broken</li> </ul>	<ul style="list-style-type: none"> <li>- Unplug the pump and wait two hours until the pump has cooled. Insert the plug and press the Massage System Button</li> <li>- Press the Massage System Button to reactivate</li> <li>- For assistance, please visit the support section on our website, <a href="http://www.bestwayusa.com">www.bestwayusa.com</a></li> </ul>
Pump adapters are not level with the spa adapters	<ul style="list-style-type: none"> <li>- One characteristic of material is that it changes shape, which is normal.</li> </ul>	<ul style="list-style-type: none"> <li>- Elevate the pump with wood or another type of insulated material to bring the pump's adapters level with the spa's adapters</li> </ul>
Spa pool air leakage	<ul style="list-style-type: none"> <li>- Spa is torn or punctured</li> <li>- Air valve is loose</li> </ul>	<ul style="list-style-type: none"> <li>- Use provided repair patch</li> <li>- Using soapy water, cover the air-valve to check if air is leaking, if so,               <ol style="list-style-type: none"> <li>1. Screw valve: fasten the air-valve by tuning the valve clockwise.</li> <li>2. For Fortifiber SPA: Deflate the spa. With one hand, hold the backside of the air valve from the inner side of the spa wall and turn the wrench clockwise.</li> </ol> </li> </ul>
Water is not clean	<ul style="list-style-type: none"> <li>- Insufficient filtering time</li> <li>- Dirty filter cartridge</li> <li>- Improper water maintenance</li> </ul>	<ul style="list-style-type: none"> <li>- Increase filtration time</li> <li>- Clean/replace the filter cartridge (refer to Filter Cartridge Cleaning and Replacement section)</li> <li>- Refer to the chemical manufacturer's instructions</li> </ul>

# ONLY FOR SPA EQUIPPED WITH Wi-Fi









Problems	Probable Causes	Solutions
The Wi-Fi setup is not successful	The pump has been connected to the wrong band	If the router your pump is connected to is dual-band and currently not connecting to a 2.4GHz network, please switch to another band of the same router (2.4GHz) and try to pair pump heater again. 5GHz networks are not supported.
	The spa pump location is too far from the router.	Check with your cell phone to see if there is full Wi-Fi signal. In case the strength of the signal on your phone is too low, check where the strength of the Wi-Fi signal is full and place the spa in that position.
	Set up with the wrong network name	Start the connection procedures again and be sure that the network name is typed correctly.
	The Wi-Fi password used during the connection is wrong	Start the connection procedures again and be sure that the password is correct.
	The strength of the Wi-Fi signal is not stable	1. Check that the router works correctly. 2. Go near the spa and check the signal on your phone. If the signal strength is not stable, check the condition of your router. If the signal strength is full, repeat the operation to connect the spa to the network.
	There is an appliance near the spa pump or the router that creates signal interference	The Wi-Fi connectivity can be interrupted by electromagnetic or other interferences. Keep the appliance away from other electronic devices that may cause interferences.
	Your phone will not connect to the Wi-Fi network during the registration	Check if the mobile device is in airplane mode. Make sure to have the airplane mode deactivated when connecting to the Wi-Fi network.
	APP Feedback	Consult the help section in the APP for extensive and up-to-date troubleshooting tips.

## Wi-Fi LED Status

Indicator light flashes slowly	Waiting to connect to the router	The pump is ready to connect to your phone
Indicator light is on	Connected to the router	The pump already connected to your phone
Indicator light flashes quickly	Lost Wi-Fi signal	Check the status of your router. The spa lost the Wi-Fi signal.
Indicator light is off	Light damaged / Wi-Fi module has problem	For more information, please visit the support section on our website, <a href="http://www.bestwayusa.com">www.bestwayusa.com</a> .



# ERROR CODES

CAUSES	REASONS	SOLUTIONS
<p>The water flow sensors work without pressing the filter or heat button.</p> 	<ol style="list-style-type: none"> <li>The water flow sensor flags didn't fall back into the correct position.</li> <li>The water flow sensors are broken.</li> </ol>	<ol style="list-style-type: none"> <li>Unplug the plug gently, strike the side of the pump but not violently, and plug it back in.</li> <li>For assistance, please visit the support section on our website, <a href="http://www.bestwayusa.com">www.bestwayusa.com</a>.</li> </ol>
<p>After starting or during the functions of filtering or/and heating, the water flow sensors do not detect water flow.</p> 	<ol style="list-style-type: none"> <li>You forgot to remove the 2 stopper caps from inside the pool.</li> <li>Filter cartridges are dirty.</li> <li>Activate the filter or heat system and put your hand in front of the outlet pipe inside the pool to check if you can feel water flowing out.               <ol style="list-style-type: none"> <li>If no water flows out the water pump is broken.</li> <li>Water flows out but the alarm <b>[E02]</b> appears, the water flow sensors are broken.</li> </ol> </li> <li>Filter blockage</li> <li>Bent pipes or poor water flow through the plastic pipes of the liner</li> <li>Debris screens are blocked: Debris screens can become blocked by hard water due to calcium build-up.</li> <li>Perished washers The washers within the spa couplings may have become perished or worn.</li> </ol>	<ol style="list-style-type: none"> <li>Remove the 2 stopper caps before heating. Refer to the Assembly section in the User's Manual.</li> <li>Remove the filter set from inside the pool and push the filter or heat button. If no alarm appears, clean or change the filter cartridges installed inside the pool.</li> <li>For assistance, please visit the support section on our website, <a href="http://www.bestwayusa.com">www.bestwayusa.com</a>.</li> <li>Clean the filter and check for damage. Replace or re-install as necessary. For assistance, please visit the support section on our website, <a href="http://www.bestwayusa.com">www.bestwayusa.com</a>.</li> <li>Please check through the spa connection to see if the pipes are bending. For assistance, please visit the support section on our website, <a href="http://www.bestwayusa.com">www.bestwayusa.com</a>.</li> <li>Empty the spa and place a garden hose inside the pipes to wash the debris. To be sure all debris are removed, perform the operation from the outside and inside of the spa. Use a toothbrush to remove any stubborn debris. For assistance, please visit the support section on our website, <a href="http://www.bestwayusa.com">www.bestwayusa.com</a>.</li> <li>Check the washers inside the coupling for damage. Unscrew the couplings and remove the washer for further inspection. For assistance, please visit the support section on our website, <a href="http://www.bestwayusa.com">www.bestwayusa.com</a>.</li> </ol>
<p>The pump's thermometer reads the water temperature below 40°F(4°C).</p> 	<ol style="list-style-type: none"> <li>The water temperature is lower than 40°F(4°C).</li> <li>If the water temperature is higher than 44.6°F(7°C), the pump's thermometer is broken.</li> </ol>	<ol style="list-style-type: none"> <li>The spa is not designed to operate with water temperatures lower than 40°F(4°C). Unplug the pump and only re-start the pump when the water temperature reaches 43°F(6°C).</li> <li>For assistance, please visit the support section on our website, <a href="http://www.bestwayusa.com">www.bestwayusa.com</a>.</li> </ol>
<p>The pump's thermometer reads the water temperature over 119°F(48°C).</p> 	<ol style="list-style-type: none"> <li>The water temperature is over 119°F(48°C).</li> <li>The ambient temperature is higher than 104°F (40°C) or the spa is exposed to direct sunlight for an extended period of time.</li> <li>If the water temperature is lower than 113°F(45°C), the pump's thermometer is broken.</li> </ol>	<ol style="list-style-type: none"> <li>The spa is not designed to operate with water temperatures greater than 104°F(40°C). Unplug the pump and only re-start the pump when the water temperature reaches 100°F(38°C) or lower.</li> <li>Disconnect the plug, detach the pump and drain the spa. After 15 minutes, reattach the pump, reconnect the plug and restart the heating function. If the alarm appears again, consider moving the spa to another location without direct sunlight.</li> <li>For assistance, please visit the support section on our website, <a href="http://www.bestwayusa.com">www.bestwayusa.com</a>.</li> </ol>
<p>The pump's thermometer connection has issues.</p> 	<ol style="list-style-type: none"> <li>The connection between the temperature sensor and the PCB may have an issue.</li> </ol>	<ol style="list-style-type: none"> <li>Unplug the spa, wait 5 minutes, and then plug it back in while switching the pump on.</li> <li>If the alarm appears again, please visit the support section on our website, <a href="http://www.bestwayusa.com">www.bestwayusa.com</a>.</li> </ol>
<p>The pump's thermometer reads the water temperature over 116.6°F(47°C).</p> 	<ol style="list-style-type: none"> <li>The water temperature is over 116.6°F (47°C)</li> <li>The ambient temperature is higher than 104°F(40°C) or the spa is exposed to direct sunlight for an extended period of time.</li> <li>If the water temperature is lower than 113°F (45°C), the pump's thermometer is broken.</li> </ol>	<ol style="list-style-type: none"> <li>The spa is not designed to operate with water temperatures greater than 104°F(40°C). Unplug the pump and only re-start the pump when the water temperature reaches 100°F(38°C) or lower.</li> <li>Disconnect the plug, detach the pump and drain the spa. After 15 minutes, reattach the pump, reconnect the plug and restart the heating function. If the alarm appears again, consider moving the spa to another location without direct sunlight.</li> <li>For assistance, please visit the support section on our website, <a href="http://www.bestwayusa.com">www.bestwayusa.com</a>.</li> </ol>
<p>Wi-Fi module connection failed.</p> 	<p>Wi-Fi module is damaged</p>	<p>For assistance, please visit the support section on our website, <a href="http://www.bestwayusa.com">www.bestwayusa.com</a>. NOTE: Press any button to remove alarm and continue to use the spa.</p>
<p>Detected electric from ground wire.</p> 	<ol style="list-style-type: none"> <li>The pump has detected electric from a ground wire. An appliance in your home may have an electric leak.</li> <li>The pump has a problem.</li> </ol>	<ol style="list-style-type: none"> <li>Call an electrician immediately to understand if power is flowing inside the grounding connection. If the problem continues, to use your spa safely, we strongly recommend connecting the spa plug to a socket with independent grounding.</li> <li>For assistance, please visit the support section on our website, <a href="http://www.bestwayusa.com">www.bestwayusa.com</a>.</li> </ol>
<p>Ground connection failed.</p> 	<ol style="list-style-type: none"> <li>The ground bonding of your home has a problem.</li> <li>The pump has a problem.</li> </ol>	<ol style="list-style-type: none"> <li>Connect the spa pump to a new socket or call an electrician to check the wall socket. If the problem continues, we suggest creating an independent grounding connection to the wall socket.</li> <li>For assistance, please visit the support section on our website, <a href="http://www.bestwayusa.com">www.bestwayusa.com</a>.</li> </ol>



### 90508E

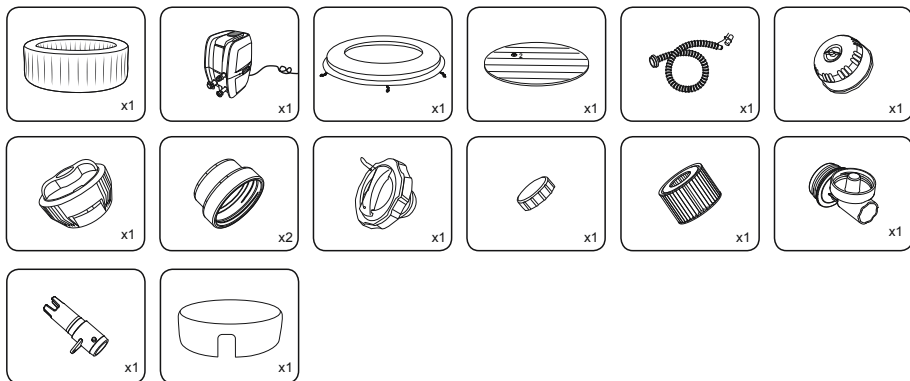

### 90524E

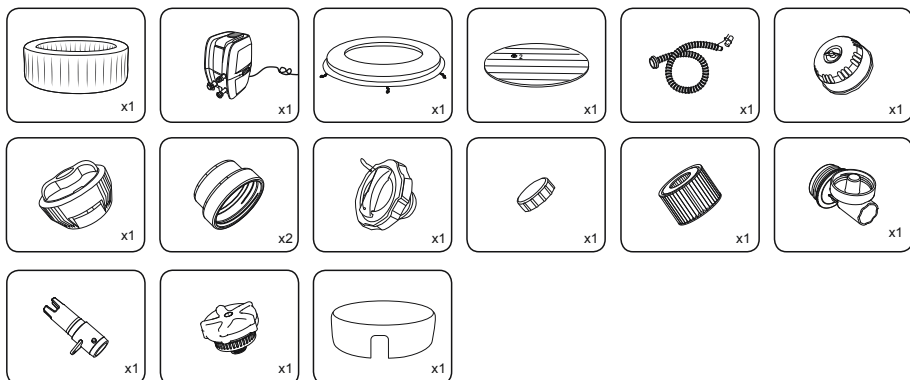

### 90363E

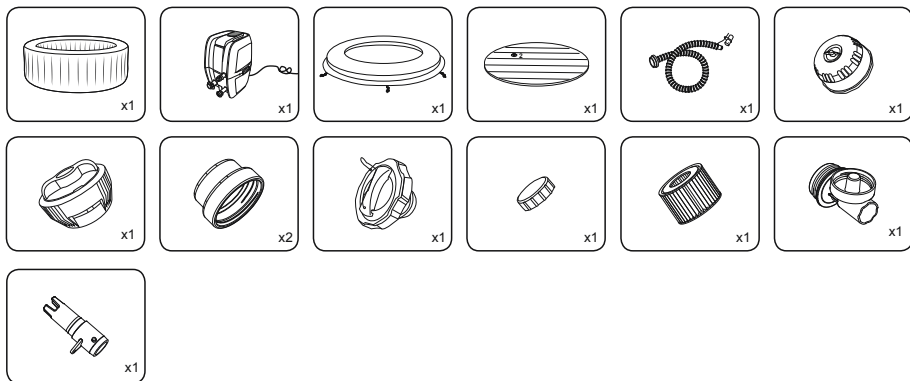



< 50°F (10°C)

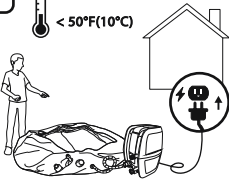

> 59°F (15°C)

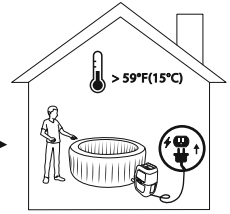
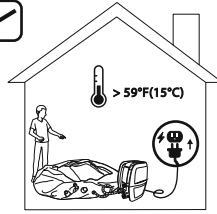

1

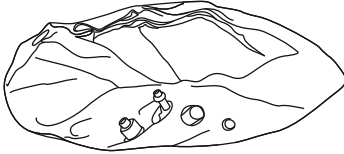

2

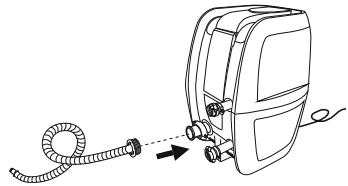

3

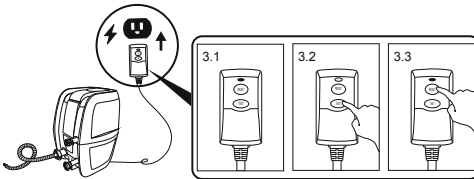

4

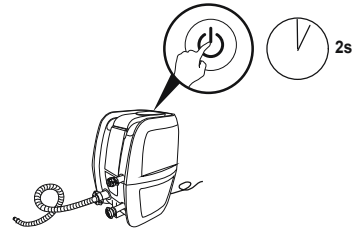

5

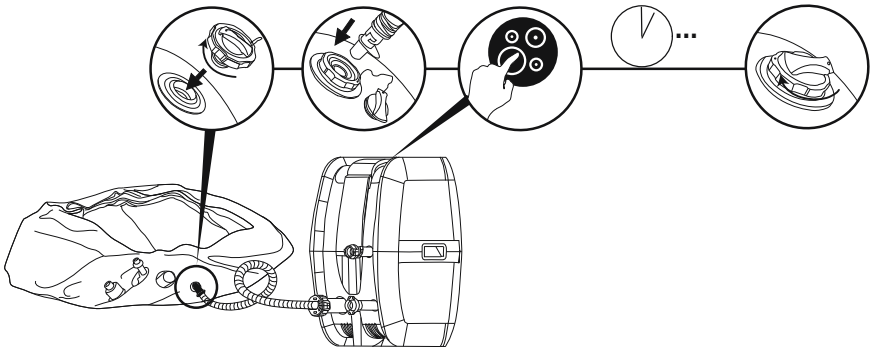

6

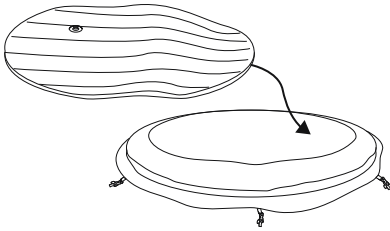

7

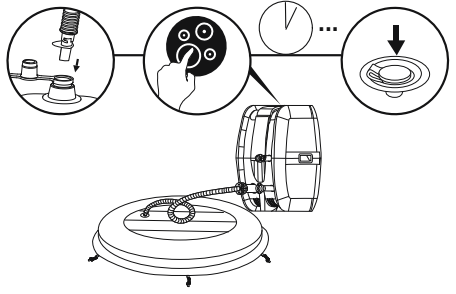

8

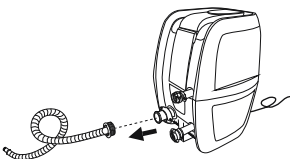

9

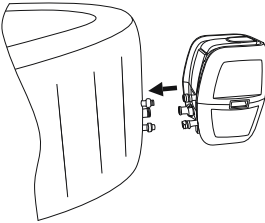

10

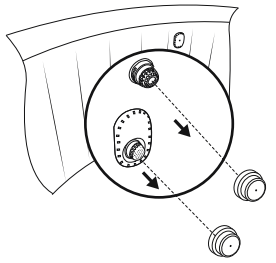

11

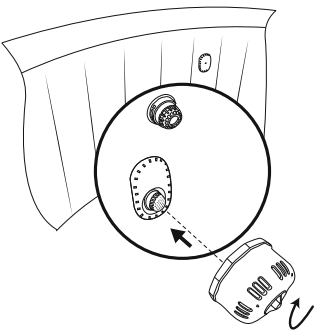

12

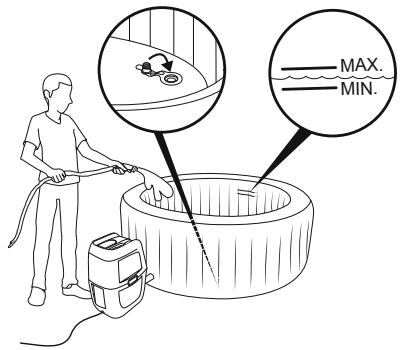



1.

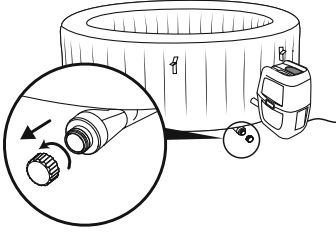

2.

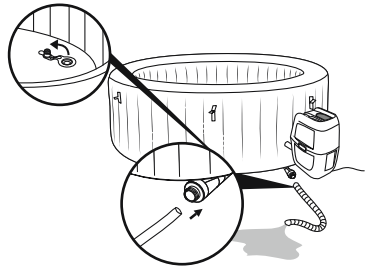

3.

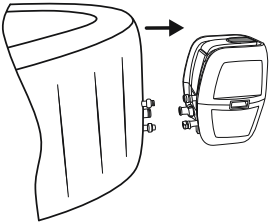

4.

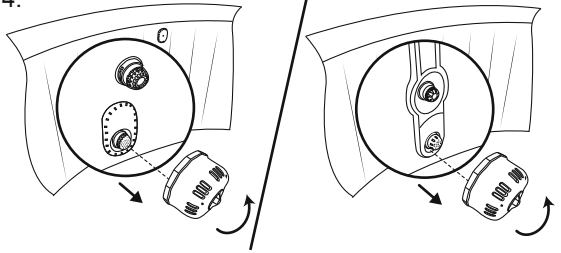

5.

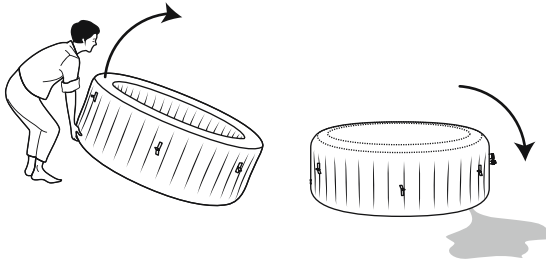

1

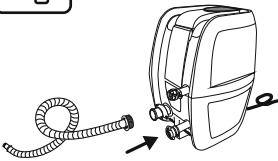

2

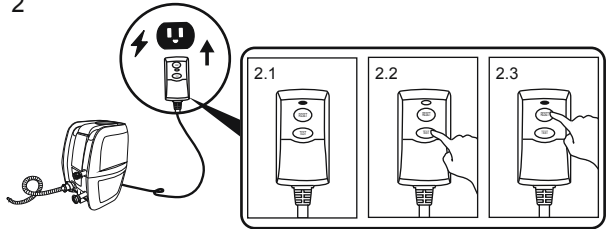

3

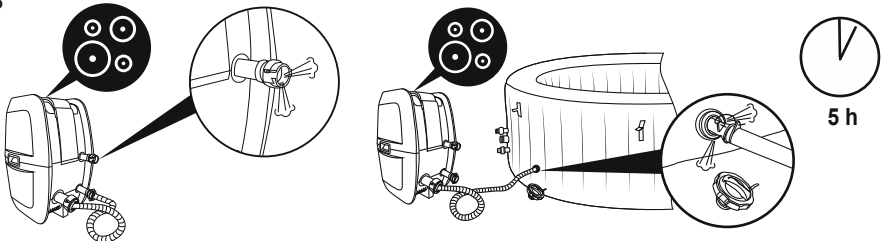



1.

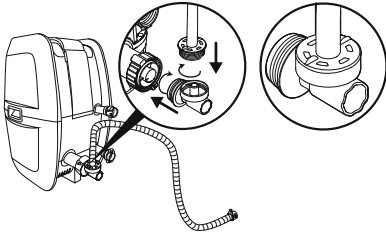

2. a.

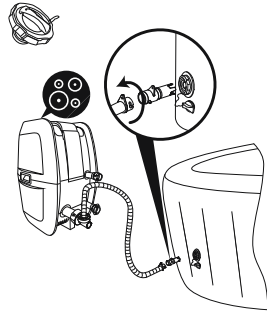

b.

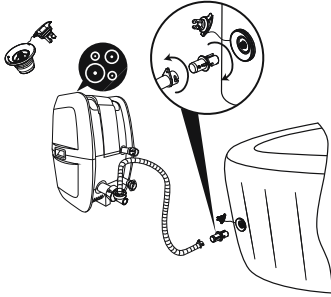

3.

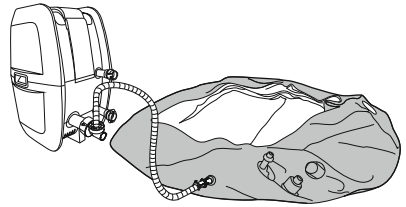

A: 1.



2.

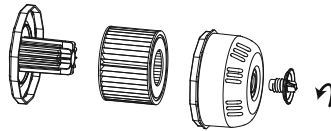

3.

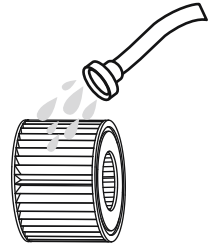

B: 1.

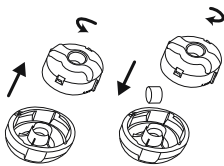

2.

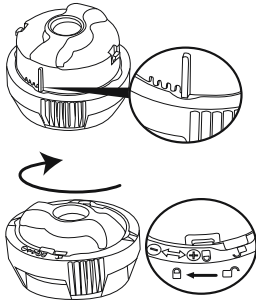

3.

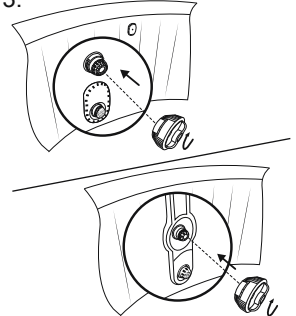





©2023 The Coleman Company, Inc.

Coleman® is a registered trademark of The Coleman Company, Inc., used under license.

Manufactured by Bestway®

©2023 Bestway (USA) Inc., 3435 S. McQueen Road, Chandler, AZ 85286, United States of America

Trademarks used in some countries under license from

**Bestway Inflatables & Material Corp., Shanghai, China**

Exported by Bestway (Hong Kong) International Ltd./Bestway Enterprise Company Limited

Suite 713, 7/Floor, East Wing, Tsim Sha Tsui Centre, 66 Mody Road, Kowloon, Hong Kong

[www.bestwayusa.com](http://www.bestwayusa.com)