

Bestway®

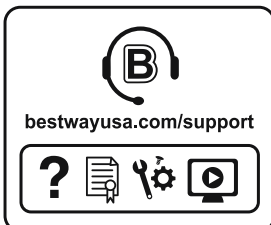

HYDRURIUM™



Visit the Bestway YouTube channel 



ATTENTION!

Before setting up your pool ensure your selected location is completely firm and level. Assemble the pool on the provided ground cloth.

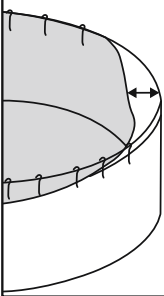
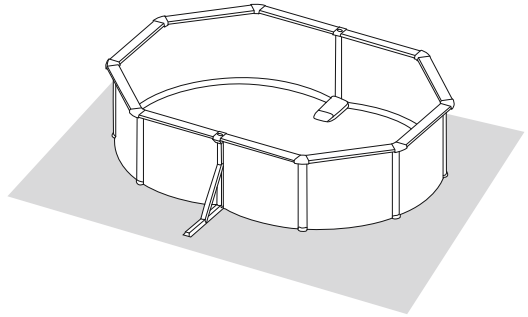
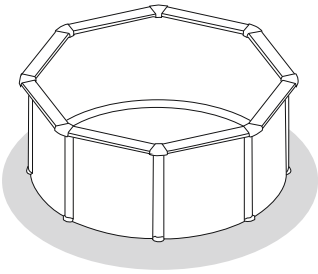

NOTE: The liner of the steel wall pool is designed to be smaller than the steel wall for technical reasons. If you find it difficult to assemble the liner, place the liner under the sun for one hour which will make it more pliable. You should then be able to assemble the liner step by step, stretching it by hand at the same time. This procedure will not damage the liner.

WARNING

 WARNING	
NO DIVING! Shallow water.  You can be permanently injured.	PREVENT DROWNING  Watch children at all times.

Only for outdoor use.

Teach your children to swim.

Never dive, jump, or slide into the pool.

Adult supervision is always required.

Parents should learn CPR.

Never swim alone.

- Keep all electrical radios, speakers and other appliances away from the swimming pool.
- When you touch the filter, pump, or electrical parts, be sure the ground under your feet is "Bone Dry".
- All electrical outlets should have a GFCI and connections should be a minimum of 5 feet (1.52 m) from the outside perimeter of the wall of the pool. From 5–10 feet (1.52–3.05 m), there should be either a fixed connection (outlet box) or twistlock connection with a GFCI.
- Connect power cords to a 3-wire grounding-type outlet only.
- Keep all breakable objects out of the pool area.
- Alcohol consumption and pool activities do not mix. Never allow anyone to swim, dive or slide under the influence of alcohol or drugs.
- Severe electrical shock could result if you install your pump or filter on a deck. The pump or filter could fall into the water, causing severe shock or electrocution. Do not install on a deck or other surface at, above, or slightly below the top rail of the pool.
- Do not use the pool during severe weather conditions, i.e. electrical storms, tornadoes, etc.
- Be aware of overhead power lines when vacuuming your pool or using a telescoping pole.
- Do not allow diving, climbing, sitting, or standing on the top rails of the pools.
- Do not allow roughhousing and horseplay.
- Do not engage in extended breath holding activities underwater; you may black out and drown.
- Install a pool ladder(s) or staircase for entry and exit from the pool.
- Keep deck clean and clear of objects that may create a tripping hazard.
- Check regularly for signs of wear or loose bolts that could make the deck unsafe.
- Instruct pool users about the proper use of all pool ladder(s) and staircases.
- Face ladder going up or down.
- Allow only one person at a time on the ladder.
- Check all nuts and bolts regularly to ensure that the ladder stays sturdy.
- Remove or secure the ladder to prevent entry to pool when not in use.
- Please contact pool site dealer or manufacturer for additional safety signs if deemed necessary.
- For pool service, select a certified pool professional.
- Any equipment connected to the circulation systems shall be positioned so as to prevent their being used as a means of access to the pool by young children.
- The installation must comply with the codes of the authority having jurisdiction and may require permits for

building, plumbing electrical, zoning, etc.

- The pool shall be located a minimum distance of 6 ft (1.83 m) from any electrical receptacle.
- All 125 volt, 15 and 20 ampere receptacles located within 20 ft (6 m) of the pool shall be protected by a ground fault circuit interrupter (GFCI). The 20 ft (6 m) distance is measured via the shortest straight line distance the supply cord would follow without piercing a floor, wall, ceiling, doorway, window, or other permanent barrier.
- Prior to use of the pool, the installer shall affix all no diving signs and safety signs in accordance with installation instructions so they can be easily visible.
- A barrier is necessary to provide protection against potential drowning and near drowning and that barriers are not a substitute for the constant supervision of children.
- A list of emergency telephone numbers shall be posted, such as the nearest available police, fire, ambulance, and/or rescue unit. These numbers are to be kept near the telephone that is closest to the pool.
- Toys, chairs, tables, or similar objects that a young child could climb shall be at least 4 feet (1219 mm) from the pool. If deck is used by the installer, it will need to comply with APSP-8.
- Basic lifesaving equipment, including one of the following, shall be on hand at all times: a. A light, strong, rigid pole (shepherd's crook) not less than 12 ft (3.66 m) long. b. A minimum ¼ in. (6 mm) diameter rope as long as 1½ times the maximum width of the pool or 50 feet (15.24 m), whichever is less, which has been firmly attached to a Coast Guard-approved ring buoy, or a similarly approved flotation devices.
- The swimming pool cover is not designated as a safety barrier.
- Please use artificial lighting during nighttime pool use, to illuminate all safety signs, ladders, steps, deck surfaces and walks.
The pool is subject to wear and deterioration. If not maintained properly, certain types of excessive or accelerated deterioration can lead to failure of the pool structure that might release large quantities of water that could cause bodily harm and property damage.
- The bottom of the pool shall be visible at all times from the outside perimeter of the pool.
- The installer of the vinyl liner shall affix on the original or replacement liner, or on the pool structure, all safety signs in accordance with the manufacturer's instructions. If have a filter pump, refer to the pump's manual for instructions.
- The ladder shall be located on a solid base and the ladder shall be installed per the ladder's instructions.
- Publications are available that describe the risk of drowning, entrapment, and diving accidents.
- Available publications related to pool safety include the Association of Pool and Spa Professionals' (APSP) booklets entitled: The Sensible Way to Enjoy Your Aboveground/Onground Swimming Pool, Children Aren't Waterproof, Pool and Spa Emergency Procedures for Infants and Children, Layers of Protection, and the latest published edition of ANSI/APSP-8 Model Barrier Code for Residential Swimming Pools, Spas, and Hot Tubs.

Please read carefully and keep for future reference

CHOOSE THE CORRECT LOCATION

The surface chosen to install the pool must respect the following technical characteristics:

1. Because of the combined weight of the water inside the pool and the pool users, it is extremely important that the surface chosen to install the pool is capable of uniformly supporting the total weight for the entire time

the pool is installed. When choosing the surface, take into consideration that water may come out of the pool when in use or in the rain. If the water softens the surface, it may lose its capability to support the pool weight.

2. We recommend positioning the pool away from any objects children could use to climb into the pool.
3. Position the pool near an adequate drainage system to deal with overflow or to discharge the pool.
4. The surface must be flat and smooth. If the surface is inclined or uneven, it can create an unbalanced loading on the structure of the pool. This situation can damage the welding point of the liner, the steel wall top and the vertical platforms. In the worst cases, the pool can collapse, causing serious personal injury and/or damage to personal property.
5. The selected surface must be clear of any type of object. Due to the weight of the water, any object under the pool could damage or perforate the bottom of the pool.
6. The selected surface must be clear of aggressive plants and weed species. Those types of strong vegetation could grow through the liner and create water leakage. The grass or other vegetation that may cause odor or slime to develop have to be eliminated from the set-up location.
7. The selected location must not have overhead power lines or trees. Be sure the location does not contain underground utility pipes, lines or cables of any kind.
8. The selected position must be far from house entrance.

Do not position any equipment or other furniture around the pool. The water that comes out of the pool during the use or due to a faulty product can damage the furniture inside the house or surrounding the pool.

9. The selected surface must be flat and without holes that can damage the material of the liner.

Follow the important instructions above to choose the correct surface and location to set up your pool. Damaged parts of the pool, due to the fact that the set-up surface and location does not match the instructions, will not be considered as manufacture defect and will avoid the warranty and any service claims.

Suggested set-up surfaces: grass, ground, concrete, and all other surfaces that respect the above set-up conditions.

Not suggested surfaces: mud, sand, gravel, deck, balcony, driveway, platform, soft/loose soil or other surface that does not meet the above set-up conditions.

Check with your local city council for by-laws relating to fencing, barriers, lighting and safety requirements and ensure you comply with all laws.

If have a filter pump, refer to the pump's manual for instructions.

The ladder must match the pool size and should be used only for entering and exiting the pool. It is forbidden to exceed the permitted payload of the ladder. Check regularly if the ladder is properly assembled.

INSTALLATION

Installation usually takes approximately 2 hours with 2-3 people excluding earthworks and filling. Please refer to diagram steps.

Tools Required (not included):



NOTE: Before connecting valve to the pool, fill the pool leaving 5 - 6 cm of space between the position of the connection valve and water surface.

WARNING: Never permanently install the connection valve before the water is within a few centimeters of them because the liner has to be properly taut from the pressure of the water.

NOTE: Be careful the splinters or any sharp edges when cutting the pool.

IMPORTANT: Cutting more liner than necessary will damage and void the pool liner, so please trim with extra care.

POOL MAINTENANCE

If you do not adhere to the maintenance guidelines below, your health might be at risk, especially that of your children.

Using chemical tablets (not included):

NOTE: Chemconnect or Chemical Floater must be used when you perform chemical maintenance with tablets. Your purchased item may not include any of those dispensers, in this case you can purchase it by visiting our website www.bestwayusa.com or at the nearest pool dealer.

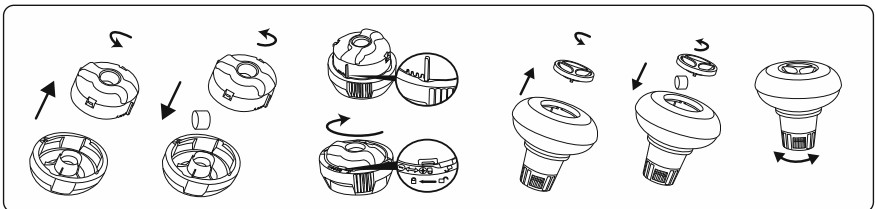

IMPORTANT: Don't use granulate tablets or throw the tablet directly in the water. The chemicals can deposit on the bottom, damage the material and discolor the PVC.

Using chemical liquid (not included):

IMPORTANT: Add chemical liquid in small doses and in the center of the pool to avoid direct contact between the chemicals and the PVC surface. Direct contact can damage the material and discolor the surface.

NOTE: Remove the chemical dispenser from pool when the pool is in use.

IMPORTANT: After performing chemical maintenance and before using the pool, use a test kit (not included) to test the water chemistry. We recommend maintaining your water according to the following table.

TEST	IDEAL VALUES
pH value	7.4 – 7.6
Cyanuric acid	30 – 50 ppm
Free chlorine	2 – 4 ppm
Chlorine compound	0
Algae	None visible
Calcium hardness	200 – 400 ppm

NOTE: Damage resulting from chemical imbalance is not covered by the warranty. Pool chemicals are potentially toxic and should be handled with care. There are serious health risks from chemical vapors and the incorrect labeling and storage of chemical containers. Please consult your local pool supply retailer for more information about chemical maintenance. Pay close attention to the chemical manufacturer's instructions. Pool damage resulting from misuse of chemicals and mismanagement of pool water is not covered by the warranty.

IMPORTANT: Over usage of chemicals can discolor the printing and all points of the pool material. It can also damage the structure of the pool liner.

To keep your pool clean:

1. Contact your local pool supply shop for advice and purchase of chemicals and pH kits. One of the most important factors to increase the life of the liner is to keep continuously clean and healthy water. Please strictly follow the instructions from professional technicians for the water treatment through the use of chemicals.
2. Locate a bucket of water next to pool to clean users' feet before entering pool.
3. Cover the pool when not in use.
4. Skim pool regularly to avoid settled dirt.
5. Check and wash the filter cartridge regularly.
6. Gently clean any scum from below the top ring with a clean cloth.
7. Please be careful in case of rain water, kindly check that the water level is not higher than the expected. If so, YOU HAVE TO DISCHARGE THE EXCESS WATER.
8. If it rains, check that the water level is not higher than the specified level. If water exceeds the specified levels, drain the pool to the specified level.

Proper maintenance can maximize the life of your pool.

During the season of use of the swimming pool, the filtration system must be necessarily put into service every day, enough time to assure at least a complete renewal of the volume of water.

NOTE: The pump is used to circulate the water and to filter small particles. In order to keep your pool water clean and hygienic, you must also add chemicals.

REPAIR

In the event of a leak, patch your pool using the underwater adhesive repair patch provided. You can find the instructions in FAQs on the support section of our website, www.bestwayusa.com.

STORAGE

1. Please remove all the accessories and spare parts of the pool and store them clean and dry.
2. Store liner and accessories in a dry place with a moderate temperature between 5°C / 41°F and 38°C / 100°F.
3. During the rainy season, pool and accessories should be stored as per above instructions also.
4. Improper draining of the pool might cause serious personal injury and/or damage to personal property.
5. We strongly recommend the pool is disassembled during the off season (winter months). Store in a dry location out of children's reach.

If you do not want to dismantle the pool in winter, please observe the following instructions:

IMPORTANT: Do not drain all of the pool water. If you do so, the pool may be damaged by strong wind. Drain the water to 10 cm below the inlet valve on the pool wall.

1. Drain the water to 10cm below the inlet valve on the pool wall. You can use a pump or a garden hose (Fig 28).
2. Treat the pool water with a suitable chemical product.
3. Remove the filtration system from the pool. You can leave the inlets/outlets attached to the pool.
4. Also remove any other pool accessories and store them in a dry and cool place.
5. Protect the pool with the pool cover.

If you want to dismantle the pool in winter, please observe the following instructions:

1. Drain the pool with a garden hose, or use a drain pump to empty the pool (Fig 28).
2. Clean every pool parts with a sponge and a soap with a neutral pH. Dry them and tidy them away in a dry and clean place.

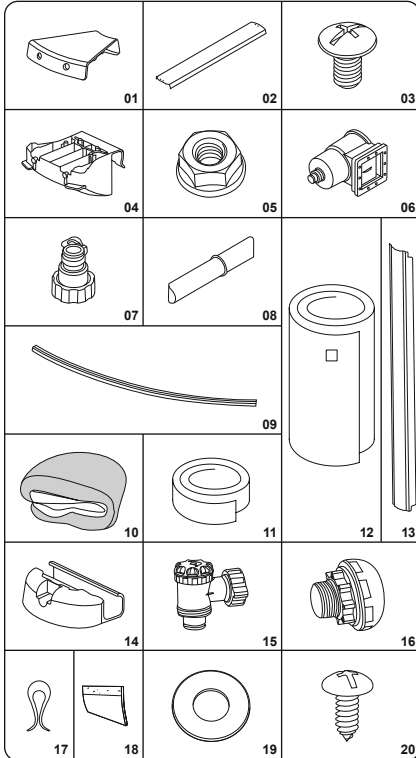

15 ft. x 48 in. (4.60 m x 1.20 m)	
256003000127	
01	x10
02	x10
03	x46
04	x10
05	x26
06	x1
07	x2
08	x40
09	x20
10	x1
11	x1
12	x1
13	x10
14	x10
15	x1
16	x1
17	x20
18	x10
19	x40
20	x60

001	x1
002	x1
003	x1
004	x1
005	x1
006	x1
007	x1
008	x12
009	x1
010	x1

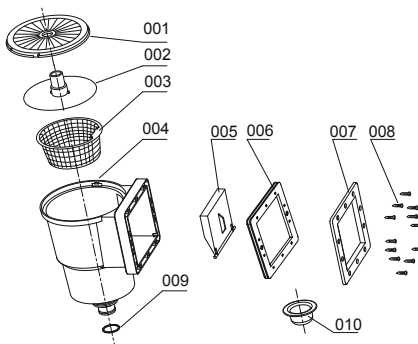

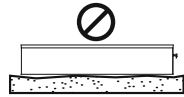
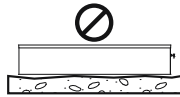
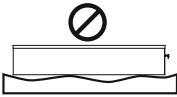
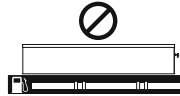
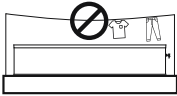
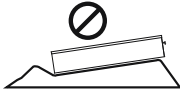
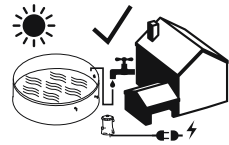
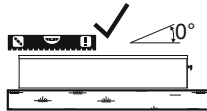
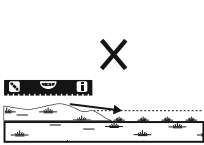

1



2

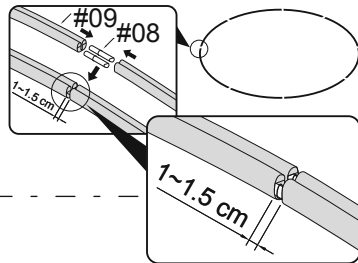

3

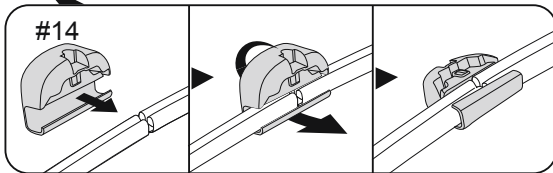

4

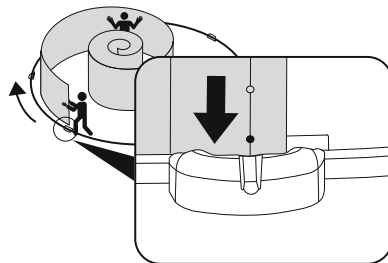

5

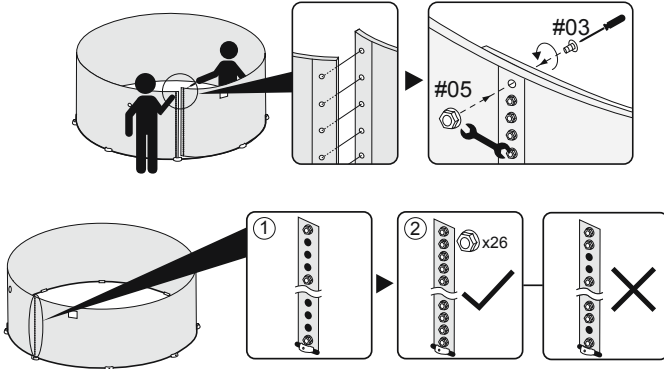

6

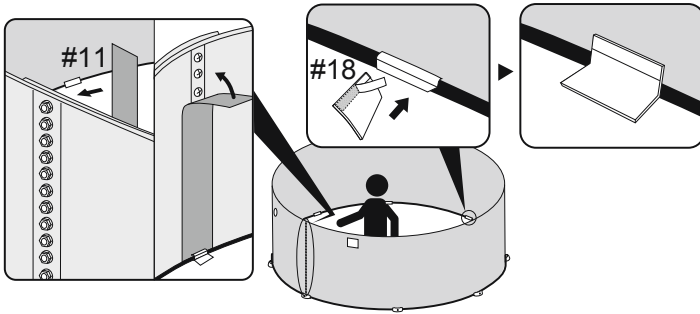

7

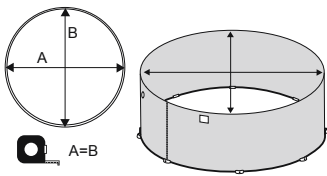

8

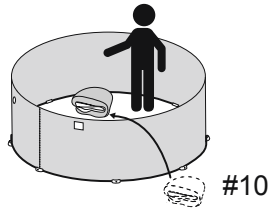

9

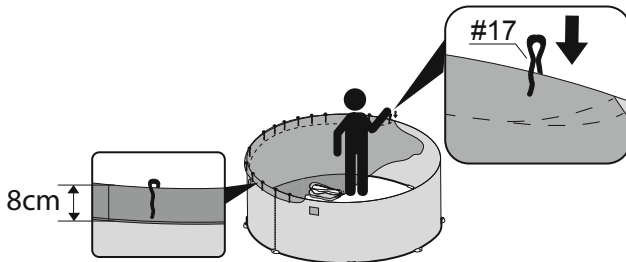

10

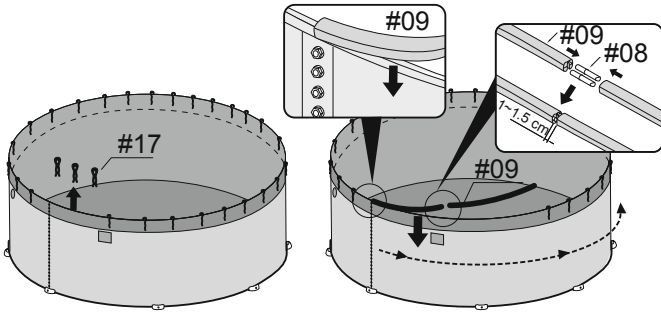

11

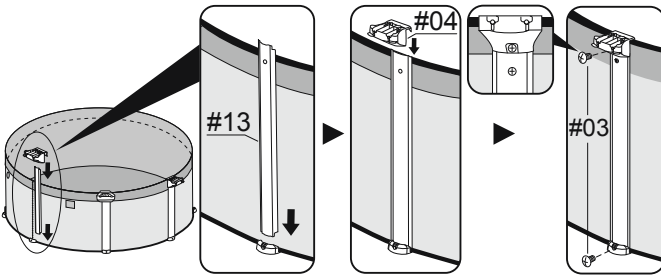

12

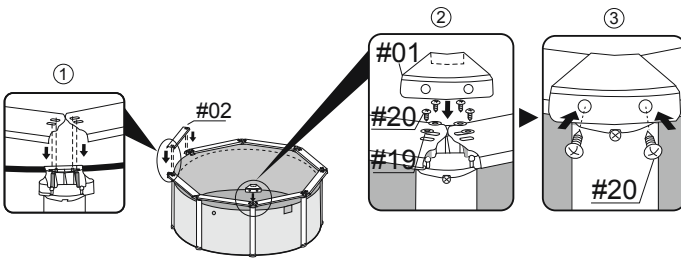

13

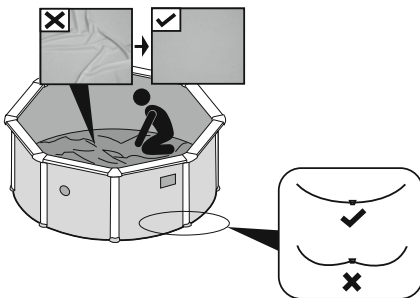

14

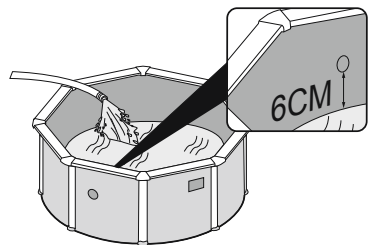

15

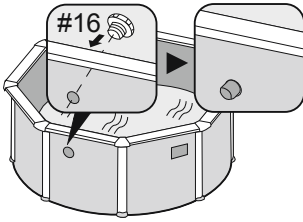

16

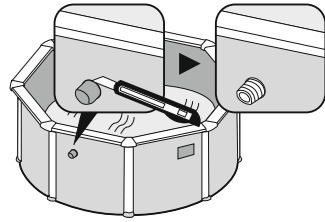

17

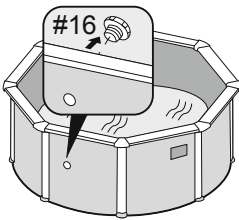

18

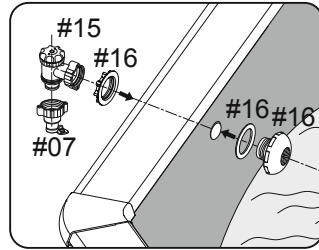

19

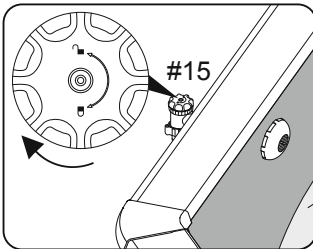

20

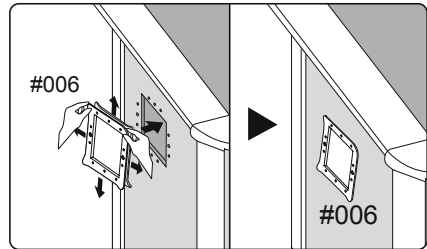

21

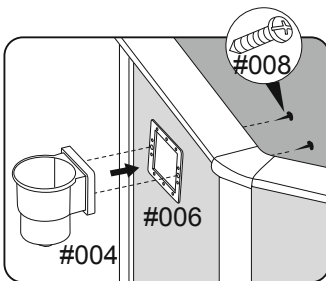

22

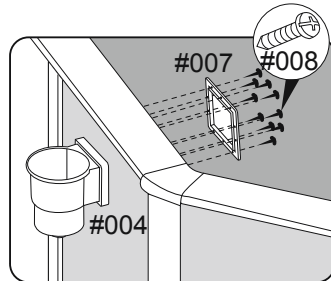

23

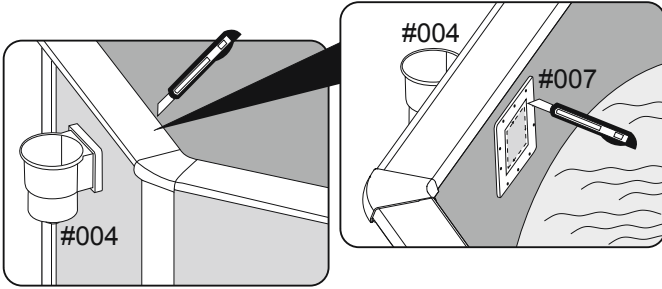

24

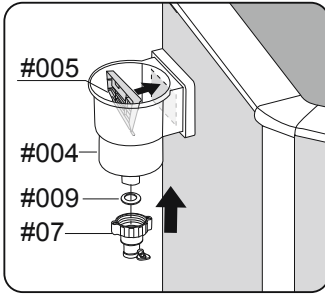

25

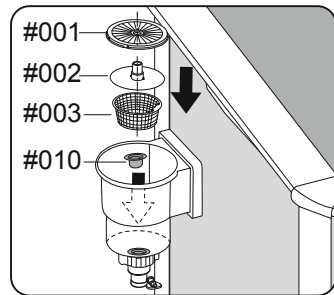

26

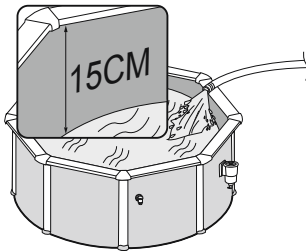

27

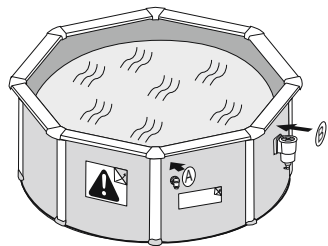

28

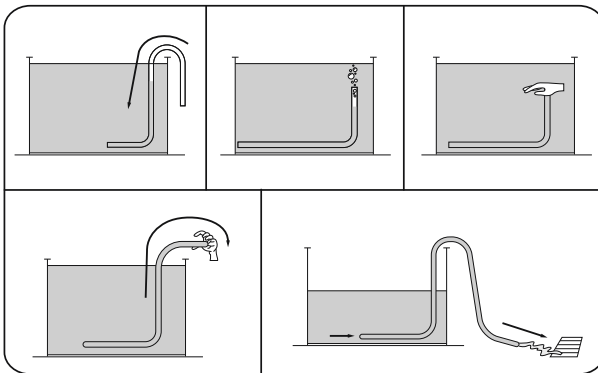



For support please visit us at:
bestwayusa.com/support

©2022 Bestway Inflatables & Material Corp.

All rights reserved

Trademarks used in some countries under license from **Bestway Inflatables & Material Corp., Shanghai, China**

Exported by **Bestway (Hong Kong) International Ltd./Bestway Enterprise Company Limited**

Suite 713, 7/Floor, East Wing, Tsim Sha Tsui Centre, 66 Mody Road, Kowloon, Hong Kong

Distributed in North America by **Bestway (USA) Inc., 3435 S. McQueen Road, Chandler, AZ 85286, United States of America**

Tel: +86 21 69135588

www.bestwayusa.com